



H390 User Manual





Index

A word from Bent	4
What's in the box	5
Quickstart	6
General Use	9
Connections	10
Digital Inputs	11
Remote Control	12
Network Configuration	13
Using AirPlay	14
Using Spotify	15
Software Update	16
Special Functions	17
General Information	18
Additional Information	19



Congratulations on your new Hegel H390.

All Hegel products are based on a simple philosophy: Add as little as possible. We always aim to keep the music signal close to the original recording. We are constantly looking for ways to lower distortion and noise. By lowering noise, we unveil layers of music covered by noise. And by lowering the distortion we can have a better and more precise reproduction of the recording. We work hard to give you the best possible music experience. Our minimalistic Scandinavian design is styled to fit in with any interior. The products are easy to operate and manufactured according to the best quality principles. The Hegel H390 has a new DAC design and now supports more formats than ever. Lots of power and versatility in the fresh new Hegel design, with the new Hegel display, sharper lines and bigger knobs.

Bent Holter
Founder Hegel Music System

What's in the box

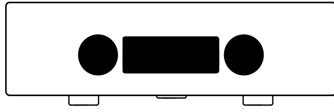

Amplifier

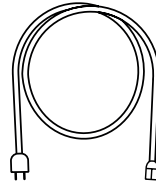

Power Cord



Accessory Box

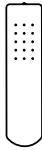

Remote Control

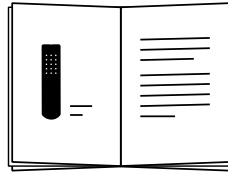

User Manual

Quickstart

1. Connect your speakers

For the best audio experience the distance between the listener and each speaker should be the same.

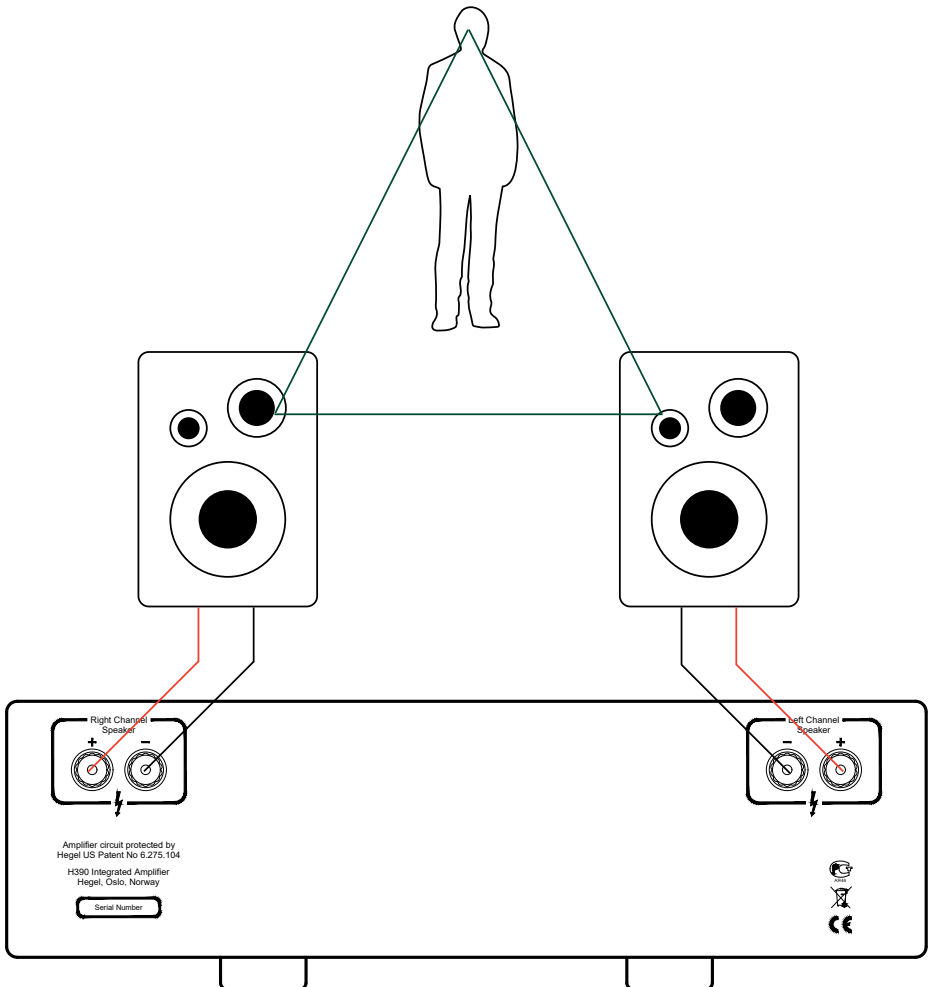

Quickstart

2. Connect a source



Unbalanced Analog

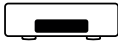
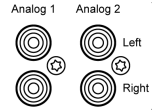

Balanced Analog

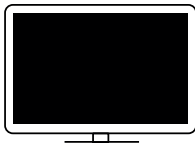
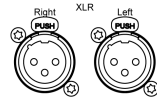

Coaxial Digital

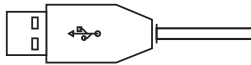

USB Computer

USB

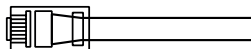

Network streaming

Network

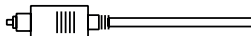

Optical Digital

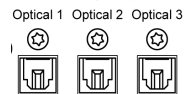

Quickstart

3. Connect the power cord

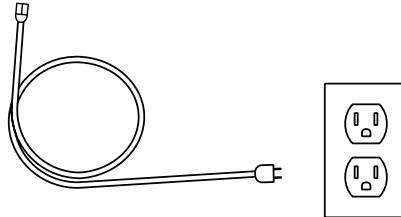
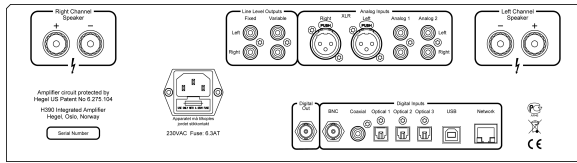

4. Turn on the amplifier

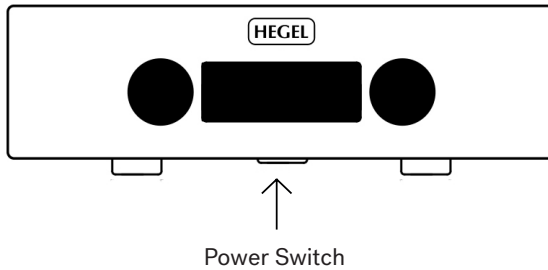

General Use

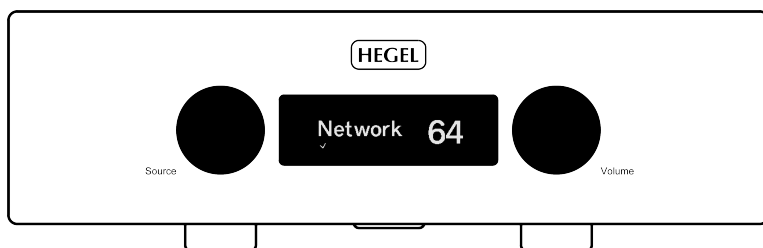

Operating the H390

The source and volume can be changed using the volume and input selector on the front panel or using the remote control. The volume level is indicated by a number between 0 and 99, with 0 being mute level and 99 being max volume. The H390 powers up at a default volume 20. This value can be changed, see Special Functions.

Power Button

The H390 amplifier is switched on and off with the power button located on the underside of the amplifier, towards the front of the unit. When powered up, the H390 takes a few seconds to calibrate. During this time, the outputs are muted.

NOTE: When powering up, the outputs are muted and the volume flashes to indicate that mute is on. This is normal, and is part of the start-up procedure.

NOTE: When the H390 has been switched off, wait 30 seconds before powering it on again.

Mute

Pressing the mute button on the Hegel remote control mutes the outputs on the amplifier. The volume flashes to indicate that mute is on. Press the mute button, or adjust the volume level, to switch mute off.

Status Indicators

The Hegel H390 will display the network status in the lower left corner.

Network status is OK:



Network status is not OK:



Connections

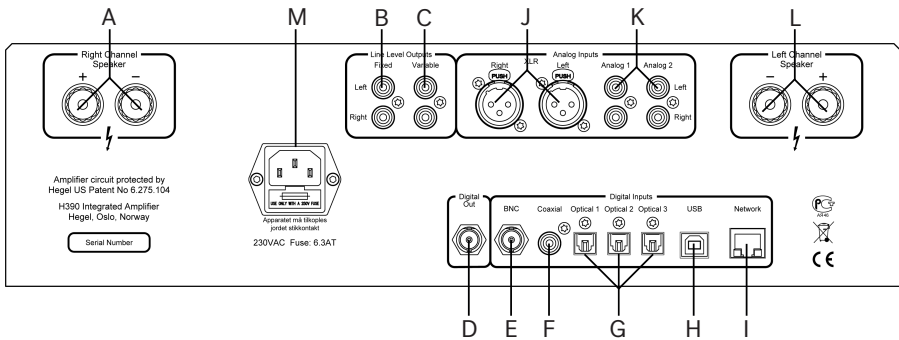

Right Channel Speaker

- Right outputs (A)

Left Channel Speakers

- Left outputs(L)

Line Level Outputs

- Fixed Line level (RCA) (B)
- **WARNING: High level output.**
- Variable Line Level (RCA) (C)

AC Power Connection

- AC Power connector with fuse holder: 230V/115V/100V AC depending on country. (M)

Digital Out (DAC loop)

- BNC: Output BNC(D)

Home Theater

Most inputs on H390 can be used as a Home Theater input, see special functions.

Digital Input

- BNC: Input BNC (E)
- Coaxial: Input Coaxial/RCA (F)
- Optical1: Input TOSLINK/EIAJ Optical (G)
- Optical2: Input TOSLINK/EIAJ Optical (G)
- Optical3: Input TOSLINK/EIAJ Optical (G)
- Computer USB input (H)
- Home network connection (LAN - RJ45) (I)

Always power the amplifier off before connecting input/output audio cables and the power cable.

Analog Inputs

- XLR (XLR): Standard balanced (J) analog input (Pin 1 is Chassis Ground; Pin 2 is Positive Phase; Pin 3 is Negative Phase)
- Analog 1(RCA): Standard analog input (K)
- Analog 2(RCA): Standard analog input (K)

Digital Inputs

Digital Inputs

The Hegel H390 supports MQA on all digital inputs. USB, BNC, Coaxial and Optical inputs have support for DSD(DoP).

USB

The Hegel H390 has a plug and play USB DAC. Connect it to your PC or Mac and enjoy all your music.

There is no driver required for Linux, Mac OS, or Windows10. If you have an older version of Windows you will need to install a driver. When connected the amplifier will show up as “Hegel H390 USB” under the speaker settings in your operating system. Using a driver “XMOS USB Audio” will be the H390 in the speaker settings. You can download a driver on our website. Go to www.hegel.com/products/integrated/H390 to download the driver.

Resolution: Up to 384 kHz 32 bit

H390 supports DSD64,DSD128,DSD256 via DoP

MQA (Master Quality Authenticated)

Hegel H390 includes MQA technology, which enables you to play back MQA audio files and streams, delivering the sound of the original master recording.

“MQA” or “MQA.” indicates that the product is decoding and playing an MQA stream or file, and denotes provenance to ensure that the sound is identical to that of the source material. “MQA.” indicates it is playing an MQA Studio file, which has either been approved in the studio by the artist/producer or has been verified by the copyright owner. “OFS” confirms that the product is receiving a decoded MQA stream or file. This delivers the final unfold of the MQA file and displays the original sample rate.

Hegel H390 supports up to MQA 8X (352.8kHz/384kHz)

Visit mqa.co.uk for more information.



Remote Control - RC8

The Hegel H390 can be controlled with the included Hegel RC8 Remote Control. The RC8 controls other Hegel products, such as amplifiers and preamplifiers, and most Media players on your Mac/PC, avoiding the need for multiple remote control devices.

The remote control uses two standard 1.5-volt LR03 AAA batteries. To insert the batteries, use a crosshead (Phillips) screwdriver to gently remove the four screws on the underside of the remote control.

Insert the batteries with the correct polarity with + sign and - sign, as shown inside the battery holder. Be careful when inserting the batteries to not damage the battery holder. Replace the cover. Insert the screws by gently turning them by hand, to avoid damaging the threads in the remote control chassis.

Do not tighten the screws too much, as this can damage the screws and the soft metal chassis of the remote control.

Caution: Do not drop the remote control on the floor, as this can damage its internal parts and the battery holder.

To avoid damage to the remote control by leakage from the batteries during transport and storage, the remote control is supplied without batteries from Hegel.

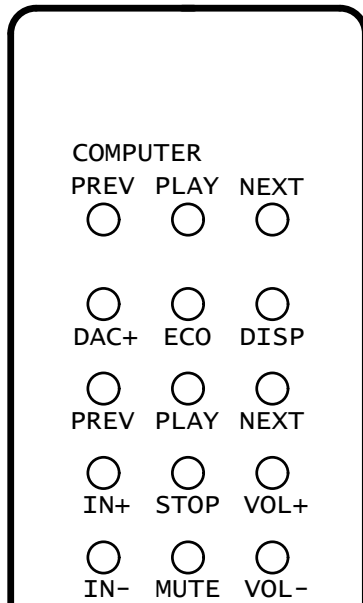

Remote control buttons (starting top left)

PREV	Skip to previous track on most computers/media players
PLAY	Play/Pause on most computers/media players
NEXT	Skip to next track on most computers/media players
DAC+	Input source selector button for Hegel DACs
ECO	This will put certain Hegel equipment in low power mode
DISP	Display on/off (hold for off)
PREV	Skip to previous track on Hegel CD-players
PLAY	Play/Pause for Hegel CD-players
NEXT	Skip to next track on Hegel CD-players
IN+	Switches up to next input on your Hegel amplifier
STOP	Stop/Eject for Hegel CD-players
VOL+	Volume up for Hegel amplifiers
IN-	Switches down to previous input on your Hegel amplifier
MUTE	Mute for Hegel amplifiers
VOL-	Volume down for Hegel amplifiers

Network Configuration

The Hegel H390 has its own Network Configuration page to where you can change the name, the IP settings and update the firmware.

Find the name of the unit by pressing and holding "COMPUTER PLAY" (2) button. A menu appears and use "COMPUTER NEXT"(3) button to choose "Network". It will then display the name and IP address of your H390.

PC/Mac: Type in the IP in your browser and the Network Configuration page opens.

Playing Files on a Network Device

The Hegel H390 can function as a Digital Media Renderer. This means that it can receive and play media files from a UPnP/DLNA compatible media player.

For details on how to set up your media player, please refer to the user manual supplied with the player.

For detailed information on the Network Configuration page, supported formats and much more please go to:
www.hegel.com/products/integrated/H390

Using AirPlay

When using AirPlay on the Hegel H390, you can send the music stream from your AirPlay compatible device, to the amplifier. Start with connecting your Hegel H390 to your local network using Ethernet cable from network connection (LAN - RJ45) on the back of the amplifier, to your router.

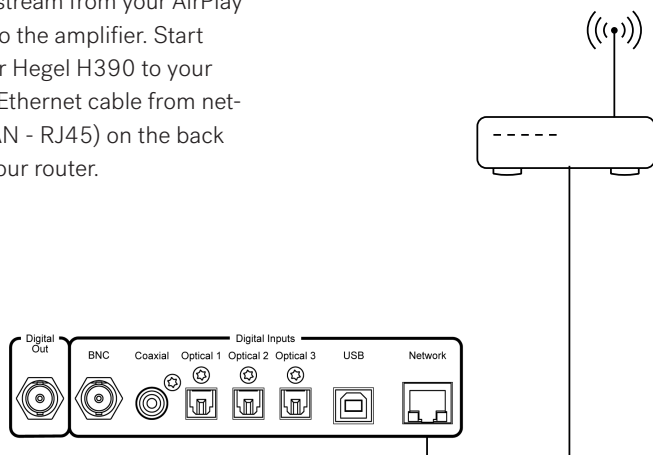

Make sure the Hegel H390 is connected to your local network.

When connected, the unit will use DHCP, and will automatically receive an IP-address and then integrate in your home network. All AirPlay compatible devices will now detect the Hegel H390 in their list of AirPlay speakers, it will be displayed as "H390", followed by a unique number.

To activate the AirPlay function on your AirPlay compatible device, you must first make sure the device is connected to the same network as the Hegel H390. For details on this please check the device manual. Then the AirPlay icon will be displayed and you can select the H390. You are now ready to send the music stream to your amplifier.

Playing from iTunes on your Hegel H390.

Install iTunes on your Mac or Windows computer. Launch iTunes, press the AirPlay Logo, and select the H390. You can also play to more than one speaker at a time, select the AirPlay logo, then "multiple" and check of the speakers that you want to listen to. You can also adjust the volume on each individual speaker.

[WARNING: After selecting the H390 as the output, always remember to check the iTunes volume-setting before pressing play. The H390 will change its volume to the volume set in iTunes, when iTunes starts playing to the H390.](#)

Using Spotify Connect

When using Spotify Connect on the Hegel H390, you can send the music stream from Spotify to the amplifier. Use the Spotify application to control the music. Start with connecting your Hegel H390 to your local network using Ethernet cable from network connection (LAN - RJ45) on the back of the amplifier, to your router.

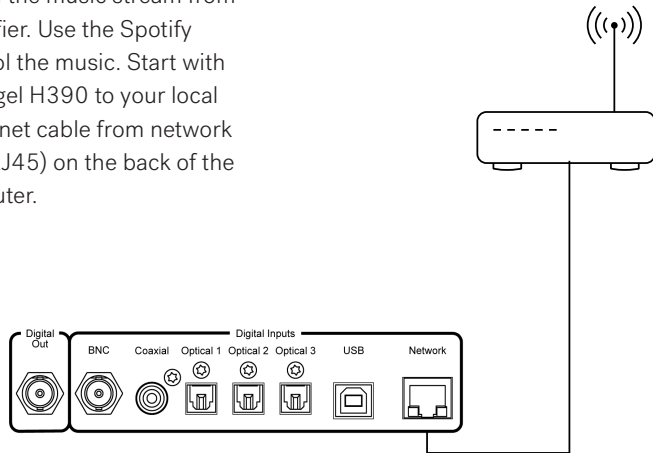

Listen out loud with Spotify Connect

1. Connect your Hegel H390 to your local network
2. Open up the Spotify app on your phone, tablet or laptop using the same local network
3. Play a song and select Devices Available.
4. Select your Hegel H390 and start listening.



Software Update

Make sure your H390 is connected to a network with an internet connection.

Hold Play on your remote control for around 5 seconds to enter the device menu.



Scroll down to the Update option by using Next and enter this menu by pressing Play.

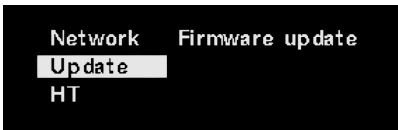

Press Play again to check for firmware updates on the internet.

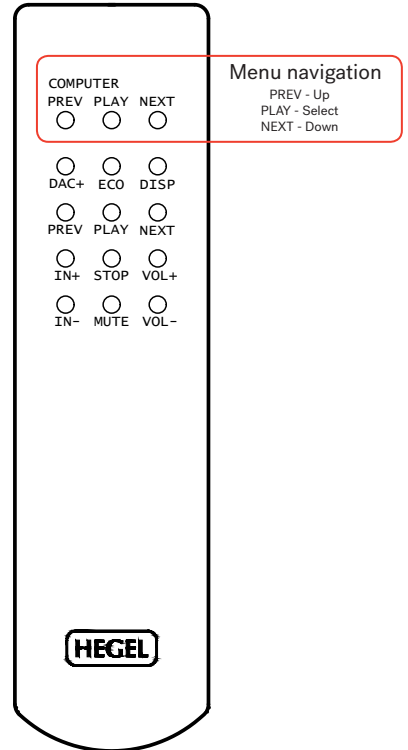
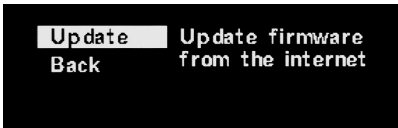

Special Functions

Display On/Off

The DISP button on the RC8 remote control may be used to turn the display of the H390 on or off. Hold the DISP button for more than 1 second to turn the display off. Press the button turn the display on.

Home Theater or Standard Analog Input

Most inputs can be changed into a Home Theater input. This will set the volume to a fixed high volume level. Use the RC8 remote to change the settings. Hold "COMPUTER PLAY" until the setup menu appears. Use computer prev/next to navigate to "HT" and press "COMPUTER PLAY" to select this submenu. Now use "COMPUTER NEXT" to maneuver to the input you want to change into a fixed level input. Press "COMPUTER PLAY" to toggle between a fixed level input or normal variable input. Now don't press anything for 15sec, and the H390 will return to normal mode.

[WARNING: Activating Home Theater sets the volume at a high fixed level. This may harm your speakers if a fixed level input is connected.](#)

Reset to Factory Default Settings

By pressing and holding the DAC+ button while pressing Mute on the RC8, the H390 will be reset to factory settings. This will clear all user defined settings, including IP settings, and reinitialize the H390.

Power Up Volume

A user defined volume value may be used as the power-up volume. The current volume is set as the power-up volume by pressing and holding the DAC+ button while pressing Vol- on the RC8 remote control.

Max Volume

A user defined volume value may be used as the max volume. The current volume is set as the max volume by pressing and holding the DAC+ button while pressing Vol+ on the RC8 remote control. To reset, put to max volume, press and holding the DAC+ button while pressing Vol+ on the RC8 remote control.

DAC-Loop

This function makes it possible to upgrade the digital inputs of the H390 with an external high-end DAC. This is done by connecting the re-clocked coaxial digital output of the H390 to the external DAC. The output of the external DAC will need to be connected to the XLR input of the H390.

Use the RC8 remote to change the settings. Hold "COMPUTER PLAY" until the setup menu appears. Use computer prev/next to navigate to "DAC-LOOP" and press "COMPUTER PLAY" to select this submenu. Press "COMPUTER PLAY" to turn on/off. Now don't press anything for 15sec, and the H390 will return to normal mode.

General Information

Technical Specifications

H390 Integrated Amplifier

Power output	2*250W in 8 ohms Dual Mono
Minimum load	2 ohms
Analog Inputs	1*Balanced (XLR) 2*Unbalanced (RCA)
Digital Outputs	1*Coaxial (BNC) S/PDIF
Digital Inputs	1*Coaxial (BNC) S/PDIF 1*Coaxial (RCA) S/PDIF 3*Optical S/PDIF 1*USB 1*Network
Line level Output	1*Unbalanced fixed(RCA), 1*Unbalanced variable(RCA)
MQA supported inputs	USB, BNC, Optical and Coaxial
Frequency response	5Hz-180kHz
Signal-to-noise ratio	More than 100dB
Crosstalk	Less than -100dB
Distortion	Less than 0.005% @ 50W 8 Ohms 1kHz
Intermodulation	Less than 0.01% (19kHz + 20kHz)
Damping factor	More than 4000 (main power output stage)
Dimensions	15cm x 43cm x 44cm (HxWxD), 20kg unit weight. 6" x 17" x 17,3" (HxWxD), 44 lbs unit weight.

Transport and Shipment

If you are packing the amplifier for shipping, please follow these instructions to avoid damaging the unit: Be careful not to hold the volume- and source-knobs when lifting the amplifier. Put the bag around the amplifier. Make sure the bottom shock absorbers are placed at the bottom of the original cardboard box. Place the amplifier into the shock absorbers. Place the top shock absorber on top of the amplifier.

Use and Placement

The Hegel H390 should be placed on a flat, hard surface for proper cooling. The amplifier performs best after being switched on for about 1 hour for heating up. A certain space is required for air circulation above and below the amplifier. The amplifier must never be placed on a carpet or similar surface that obstructs air circulation through the unit. Nor must it be covered while in use or placed on a narrow shelf or in another confined space.

The amplifier will automatically switch itself off if overheated. When it cools down the relays kick in and the amplifier sets the volume to 0.

Cleaning

Fingerprints or stains on the front panel or top cover can be removed with a cloth moistened with warm water or a mild detergent suitable for cleaning mirrors and windows.

Additional Information

Warning

Hegel products should only be opened or serviced by certified technicians. The devices contain electronic components that may cause severe electric shock. Work performed on Hegel products by unqualified personnel may cause serious damage or personal injury.

Opening of the product by non-authorized personnel will void the guarantee.

The products must not be exposed to rain or moisture.

Warranty

All Hegel products come with a 2-year warranty against defective materials and workmanship.

In case you would need any assistance with your Hegel product please find your nearest dealer or distributor by looking at the Hegel web site www.hegel.com. If you experience any problems locating your dealer or distributor please contact info@hegel.com

For more information about the H390, please visit www.hegel.com/products/integrated/H390



The Spotify Software is subject to third party licenses found here: www.spotify.com/connect/third-party-licenses



AirPlay works with iPhone, iPad, and iPod touch, or Mac and PC with iTunes.

Use of the Works with Apple badge means that an accessory has been designed to work specifically with the technology identified in the badge and has been certified by the developer to meet Apple performance standards.

Apple, iPad and iPhone are trademarks of Apple Inc., registered in the U.S. and other countries. The trademark "iPhone" is used in Japan with a license from Aiphone K.K.



The MQA logo is a trade mark of MQA Limited. © MQA Limited 2018

