

T+A

USER MANUAL

HV-SERIES

SDV 3100 HV



Welcome.

We are delighted that you have decided to purchase a **T+A** reference class product. With your new **SDV 3100 HV** you have acquired a top-quality piece of equipment which has been designed and developed with the wishes of the audiophile music lover as absolute top priority.

This system represents our very best efforts at designing practical electronic equipment incorporating solid quality, user-friendly operation and a specification and performance which leaves nothing to be desired.

All these factors contribute to a piece of equipment which will satisfy your highest demands and your most searching requirements for a period of many years. All the components we use meet the German and European safety norms and standards which are currently valid. All the materials we use are subject to painstaking quality monitoring.

At all stages of production we avoid the use of substances which are environmentally unsound or potentially hazardous to health, such as chlorine-based cleaning agents and CFCs.

We also aim to avoid the use of plastics in general, and PVC in particular, in the design of our products. Instead we rely upon metals and other non-hazardous materials; metal components are ideal for recycling, and also provide effective electrical screening.

Our robust all-metal cases exclude any possibility of external sources of interference affecting the quality of reproduction. From the opposite point of view our products' electro-magnetic radiation (electro-smog) is reduced to an absolute minimum by the outstandingly effective screening provided by the metal case.

The case of the **SDV 3100 HV** is built exclusively from the finest-quality non-magnetic metals of the highest purity. This excludes the possibility of interaction with the audio signals, and guarantees uncoloured reproduction.

We would like to take this opportunity to thank you for the faith you have shown in our company by purchasing this product, and wish you many hours of enjoyment and sheer listening pleasure with your **SDV 3100 HV**.

T+A elektroakustik GmbH & Co KG

License Notice

This product contains software in form of object code that is partially based on free software under different licenses, especially the GNU General Public License. You can find details on this in the License Information which you should have received with this product.

If you have not received a copy of the GNU General Public License, please see <http://www.gnu.org/licenses/>.

For a period of three years after last distribution of this product or its firmware, T+A offer the right to any third party to obtain a complete machine-readable copy of the corresponding source code on physical storage medium (DVD-ROM or USB stick) for a charge of 20€. To obtain such copy of the source code, please write to the following address including information about product model and firmware version: **T+A elektroakustik, Planckstr. 9-11, 32052 Herford, Germany.**

The GPL license and further information about Licenses can be found on the internet under this link:

<http://www.ta-hifi.com/license-information>

It is also possible to retrieve the used licenses directly from the device with the help of an Internet browser. For details, see the chapter entitled "**Legal Information**".



Qualcomm is a trademark of Qualcomm Incorporated, registered in the United States and other countries, used with permission. aptX is a trademark of Qualcomm Technologies International, Ltd., registered in the United States and other countries, used with permission

HD Radio™ technology only available in US-version.



HD Radio Technology manufactured under license from iBiquity Digital Corporation. U.S. and Foreign Patents. HD Radio™ and the HD, HD Radio, and "Arc" logos are proprietary trademarks of iBiquity Digital Corp.

Supported by:



Federal Ministry
for Economic Affairs
and Energy

on the basis of a decision
by the German Bundestag

About these instructions

All the controls and functions of the **SDV 3100 HV** which are frequently used are described in the first section of these operating instructions.

The second part '**Basic settings, Installation, Using the system for the first time**' covers connections and settings which are very seldom required; they are generally required only when the machine is set up and used for the first time. Here you will also find a detailed description of the network settings required for connecting the **SDV 3100 HV** to your home network.

Symbols used in these instructions



Caution!

Text passages marked with this symbol contain important information which must be observed if the machine is to operate safely and without problems.



This symbol marks text passages which provide supplementary notes and background information; they are intended to help the user understand how to get the best out of the machine.

Notes on software updates

Many features of the **SDV 3100 HV** are software based. Updates and new features will be made available from time to time. The update process takes only a few minutes. See the chapter entitled "Software update" for how to update your device via the internet connection.

We recommend you to check for updates before using your **SDV 3100 HV** for the first time. To keep your device up to date you should check for updates from time to time.



The operation instructions, the connection guidance and the safety notes are for your own good - please read them carefully and observe them at all times. The operating instructions are an integral part of this device. If you ever transfer the product to a new owner please be sure to pass them on to the purchaser to guard against incorrect operation and possible hazards.



All the components we use meet the German and European safety norms and standards which are currently valid. This product complies with the EU directives. The declaration of conformity can be downloaded from www.ta-hifi.com/DoC.

Contents

Page

Introduction	9
PCM and DSD.....	9
SDV 3100 HV and DSD.....	9
SDV 3100 HV and PCM.....	10
Front panel controls	11
Remote control	15
Basic settings of the SDV 3100 HV	17
Calling up and operating the menu	17
D/A configuration.....	17
Source names	18
Pass through	18
Analog output.....	18
Headphone mode.....	18
Left rotary knob	18
Display Brightness.....	18
Display Mode.....	19
Language.....	19
Device name.....	19
Energy Saver	19
Network.....	19
Music services	19
Bandwidth limit.....	20
Device Info.....	20
D/A-Converter settings of the SDV 3100 HV	21
Calling up and operating the menu	21
Balance	22
PCM D/A mode	22
DSD D/A mode.....	22
Output	22
Bandwidth.....	22
Operating the source devices in detail	24
Operation with the F3100 remote control.....	24
Operation with controls on the front panel of the device	24
Favourites lists	25
General information.....	25
Adding a favourite.....	25
Erasing a favourite from the Favourites list.....	25
Selecting a favourite from the list.....	26
Directly selecting a favourite.....	26
Sorting Favourites lists.....	26
Operating the radio	27
FM – Radio	27
Selecting FM radio.....	27
Manual station search.....	27
Searching for an HD Radio station	28
Automatic station search	28
Selecting a station from the Station list	28

RDS functions.....	29
Switching Radio Text on and off.....	29
Mono / Stereo	29
DAB - Radio.....	29
Selecting DAB radio.....	29
Automatic station search.....	30
Selecting a station from the Station list.....	30
RDS functions.....	30
Internet Radio source (Streaming www)	31
Selecting Internet Radio as source.....	31
Selecting podcasts.....	31
Playback	31
Favourites list.....	31
Search function	32
Operating music services	33
General information.....	33
Selecting a music service.....	33
Playback	33
Search function	34
Playlists and favourites.....	34
Operating the UPnP / DLNA source (Streaming Client).....	35
General information on the streaming client.....	35
Selecting the UPnP / DLNA source.....	35
Playback	35
Playback of directories.....	36
Search function	36
Front panel display.....	36
Playing USB memory media.....	37
General information.....	37
Selecting USB Media as source	37
Playback	37
Playback of directories.....	38
Search function	38
Operating the Bluetooth source	39
Selecting the Bluetooth Audio source	39
Setting up audio transfer	39
Playback functions.....	39
Controlling the SDV 3100 HV	40
NOTES.....	40
The SDV 3100 HV as D/A Converter.....	41
General Information	41
D/A Converter Operation.....	41
Selecting a D/A Converter Source.....	41
Screen Display.....	41
USB DAC operation in detail	42
System-requirements	42
Installing drivers.....	42
Settings.....	42
Notes on software	42
Notes on operation	42
Notes on setting up	42
Network Audio Adapter (NAA)	43

General information.....	43
Hardware and software requirements.....	43
Network, connections.....	43
Playback.....	43
Installation Using the system for the first time Safety notes	46
Back panel connections	47
Installation and wiring.....	50
Safety notes.....	52
Network Configuration	54
General Information.....	54
Compatible hardware and UPnP servers	54
Network settings menu	54
Opening the network settings menu	54
Operating the menu, changing and storing IP addresses.....	54
Closing the menu	55
Interrupting the menu without storing the settings.....	55
The Configuration for a Wired Ethernet LAN or Power-Line LAN connection	56
Setting the Parameters for a Wired Network.....	56
The Configuration for a WLAN connection.....	58
Setting the parameters for a wireless network	58
Selecting and connecting a WLAN by hand	58
Searching for and Selecting the Network	58
Entering the Password (for encoded networks).....	58
Storing Network Settings and Restarting.....	58
Connecting to WLAN via the WPS-function.....	59
WPS-function.....	59
Connecting WLAN automatically via the WPS function	59
Selecting the WLAN manually and connecting via WPS	59
WLAN setup via access point	60
General information	60
Music Navigator App.....	60
Setup WLAN.....	60
Notes on Energy Saving	61
Firmware update.....	62
Technical description – D/A conversion.....	63
PCM.....	63
DSD	65
Network Terminology	67
Trouble shooting.....	69
Appendix A	72
Wiring diagram	72
Appendix B	76
Specification.....	76

Introduction

PCM and DSD

Two competing formats are available in the form of PCM and DSD, both of which are used to store audio signals at very high resolution and quality. Each of these formats has its own specific advantages. A vast amount has been written about the relative merits of these two formats, and we have no intention of participating in the dispute, much of which is less than objective in nature. Instead we consider it our task to develop equipment which reproduces both formats as effectively as possible, and exploits the strengths of each system to the full.

Our many years of experience with both systems have clearly shown that PCM and DSD cannot just be lumped together; it is essential to treat each format separately, and take their specific requirements into account. This applies both at the digital and analogue level.

For this reason the **SDV 3100 HV** employs two separate digital sections, two D/A converter sections and two analogue back-ends - each optimised for one format.

SDV 3100 HV and DSD

By its nature the DSD format involves a noise floor which rises above the range of human hearing as frequency rises. Although this noise floor is not directly audible, it does subject the treble units in the loudspeakers to a significant load. It is also possible for the high-frequency noise to cause distortion in many low-bandwidth amplifiers.

The lower the DSD sampling rate, the more severe the inherent noise, and it cannot be disregarded, especially with the DSD64 format - as used on the SACD. As the DSD sampling rate rises, the high-frequency noise becomes increasingly insignificant, and with DSD256, DSD512 and DSD1024 it is virtually irrelevant. In the past it has been standard practice to apply digital and analogue filtering processes in an attempt to reduce DSD noise, but such solutions are never entirely without side-effects on sound quality. For the **SDV 3100 HV** we have developed two special techniques designed to eliminate the sonic disadvantages:

- 1.) The **T+A** True-DSD technique, consisting of a direct digital signal path without filtering and noise-shaping, plus our True 1-bit DSD D/A converter
- 2.) Analogue reconstruction filter with selectable bandwidth

The **T+A** True-DSD technique is available for DSD sampling rates from DSD64 upwards.

High-resolution music, recorded natively in DSD format, is available e.g. from Native DSD Music at www.nativedsd.com. A free test sampler is also available for download there*.



* Status 05/19. Changes possible.

The PCM process makes extremely high-resolution sampling values available: up to 32 bits. However, the sampling rate of PCM is significantly lower than that of DSD, and the spacing in terms of time between the sampling values is greater.

This means that it is extremely important with PCM to employ maximum possible precision when converting the high resolution into analogue signals. Here at our answer was to develop quadruple D/A converters which provide a four-fold improvement in accuracy over conventional converters. A further very important aspect of PCM reproduction is to reconstruct the curve of the original analogue signal between the sampling points with great accuracy, since these points are much more widely spaced in comparison with DSD. To this end the **SDV 3100 HV** employs a polynomial interpolation process (Bezier-Spline interpolation) developed in-house at , which in mathematical terms delivers the smoothest curve for a given number of reference points (sampling points). The output signal generated by Bezier interpolation exhibits a very “natural” shape, devoid of the digital artefacts - such as pre- and post-oscillation - which are usually produced by the standard oversampling process. More detailed information on this can be found in the chapter **“Technical description, oversampling / up-sampling”**

And one final comment: If you intend to carry out your own tests to decide whether DSD or PCM is the superior format, please be sure to compare recordings with comparable information density – i.e. DSD64 with PCM96/24, DSD128 with PCM 192 and DSD256 with PCM384!

Front panel controls

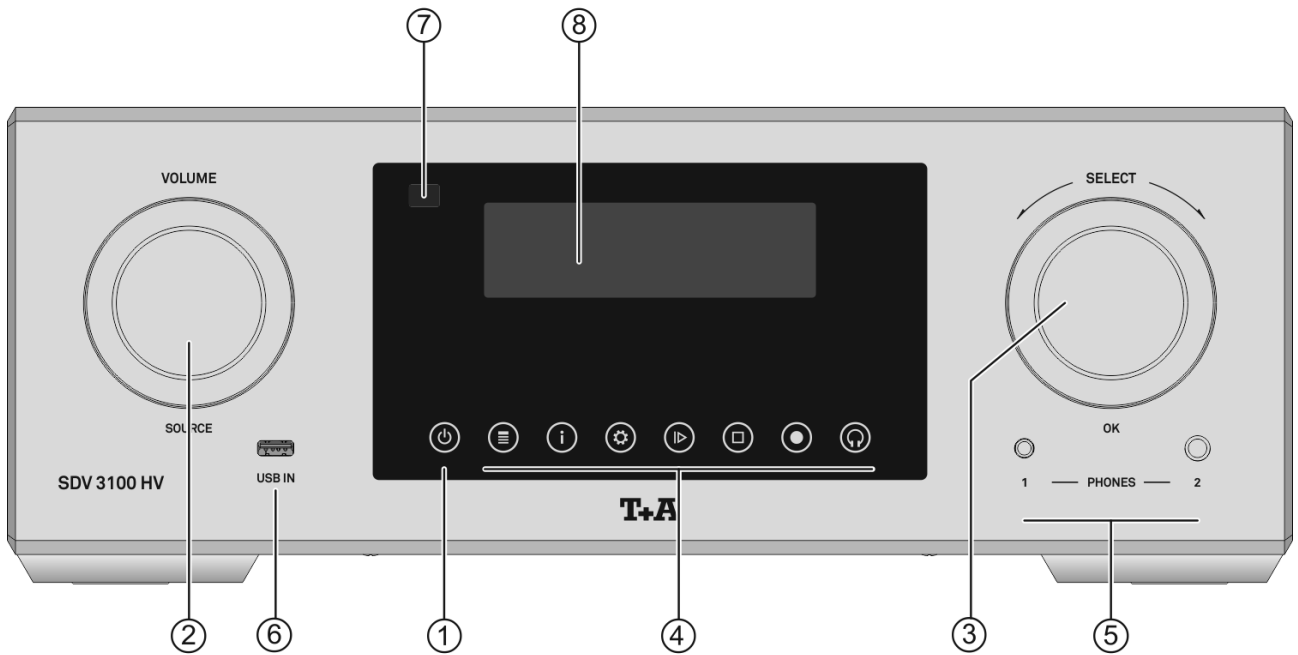

All the important functions of the **SDV 3100 HV** can be controlled using the buttons and rotary knobs on the front panel. The large rotary knobs are used for navigation in lists and menus and to select the listening source. Functions which are needed less frequently are controlled using a menu which is called up by pressing the -button.

All information relating to the machine's state, the current track and the associated transmitting station are displayed on the integral screen.

① ON / OFF SWITCH



Touching the -button briefly switches the device on and off.



The -button remains dimly lit even in stand-by mode, to indicate that the **SDV 3100 HV** is ready for use.



Caution!

The -button is not an isolation switch. Certain parts of the machine remain connected to mains voltage even when the screen is switched off and dark. To disconnect the device completely from mains power supply, the mains plugs must be withdrawn from the wall socket.

If you know you will not be using the machine for a long period, we recommend that you disconnect it from the mains.

② VOLUME CONTROL / SOURCE SELECTION

VOLUME / SOURCE

This rotary knob is used to set your preferred volume in accurate 1 dB increments. The value currently set is displayed on the screen.

The desired listening source is selected by turning this rotary knob; your chosen source then appears on the screen. After a short delay the machine switches to the appropriate source.



The main function of this knob can be changed if necessary. In this case, the button must be pressed briefly before the volume can be changed (see chapter '**Basic settings of the SDV 3100 HV**').



A long press on this knob switches to balance adjustment: turning the knob to left or right then alters the balance in the corresponding direction. Press the knob again long to conclude the adjustment and save the setting.

③ NAVIGATION / CONTROL

SELECT

Rotating this control selects a track for playback; the selected track then appears on the screen. As soon as the desired track number lights up, the track can be started by pressing the incremental control.

- ⓘ In addition to selecting tracks, the SELECT-knob also has other purposes such as menu and list control functions. For further details see the chapter entitled '**Basic settings of the SDV 3100 HV**'

④ OPERATING BUTTONS



Calls up the Favourites list



Brief touch: Switches the display view from list navigation to the current played music track. / switches the CD- / Radio - Text on and off.
Long touch: Switches between different screen displays



Opens the '**System Configuration**' menu
(for further details see the chapter entitled '**Basic settings of the SDV 3100 HV**')



Starts playback
Halts current playback (pause)
Resumes playback after a pause



Ends playback



A brief press switches the outputs (XLR and Cinch) on and off (MUTING function).

- ⓘ The outputs can also be switched automatically alternating with the headphone jack. In automatic mode, the button is not visible when the headphones are connected.
See chapter '**Basic settings of the SDV 3100 HV**'.



This button is used to switch the headphone output on and off.

- ⓘ The headphone jack can also be switched automatically alternating with the preamplifier outputs. In this case, the button is only visible when headphones are connected. See chapter '**Basic settings of the SDV 3100 HV**'.

⑤ HEADPHONES

PHONES

Sockets for stereo headphones with a minimum impedance of 16 Ω.
Connection via a standard 6.3 mm jack socket or a symmetrical 4.4 mm Pentacon jack socket.

- ⓘ In headphone mode, the volume setting is independent of the main volume setting. The set values are stored or recalled each time you switch between headphone and normal mode.
- ⓘ It is possible to connect two headphones at the same time, but this is not recommended for reasons of sound quality. If two headphones are connected, the impedance of each headphone must be at least 32 Ω.



Note regarding the use of headphones

Continuous listening to programme material at very high volume using headphones or earphones can result in permanent loss of hearing. You can avoid subsequent health problems by avoiding continuous listening at high volume through headphones or earphones.

⑥ FRONT USB SOCKET (USB IN)

USB IN

Socket for a USB memory stick or an external hard disc.

The storage medium can be formatted with the FAT16, FAT32, NTFS, ext2, ext3 or ext4 file system.

The USB storage medium can be powered via the USB socket provided that its current drain meets the USB norm (< 500 mA). Normalised 2.5" USB hard discs can be connected directly to this socket, i.e. they require no mains PSU.

⑦ REMOTE CONTROL RECEIVER

When using the remote control system please point the **F3100** handset in the direction of the receiver.

It is essential to prevent potentially interfering light (from fluorescent lamps and energy-saving bulbs) falling directly on the receiver, as this may markedly reduce the effective range of the remote control system.

The line of sight between the **F3100** and the remote control receiver in the **SDV 3100 HV** must not be interrupted by any obstacles.

⑧ DISPLAY

The graphic screen of the **SDV 3100 HV** displays all information regarding the status of the machine, the music track currently being played and the radio station currently tuned. The display is context-sensitive and varies according to the capabilities and facilities of the service or medium to which you are currently listening.

The most important information is highlighted on the screen in a context-sensitive manner. Supplementary information is displayed above and below the main text, or by means of symbols.

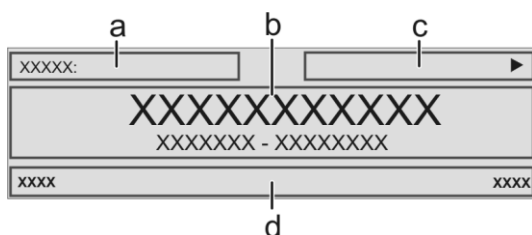



The displays and symbols which appear on the screen vary according to the currently active function (Tuner, UPnP, etc.) and the type of music currently being played.

















The basic areas of the screen:

- Display field (a) shows the currently active source.
- Display field (b) shows information relating to the piece of music being played. The essential information is displayed enlarged in the main line.
- Display field (c) shows information relating to the device and playback.
- The bottom line (d) displays supplementary context-sensitive information (e.g. bitrate, elapsed time, state of reception)

 The **SDV 3100 HV** provides different screen displays for the different sources e.g. UPnP/DLNA and the radio.

- **Large-format display:**
Enlarged display of the most important information, clearly legible even from a distance
- **Detail display:**
Small-text display showing a large number of additional information points, e.g. bit-rate etc.
A long press on the  button on the remote control handset or the  button on the front panel is used to switch between the display modes.

Screen symbols and their meaning

	Making connection (Wait / Busy) The rotating symbol indicates that the SDV 3100 HV is currently processing a command, or is attempting to connect to a service. These processes may take some time to complete depending on the speed of your network and the load upon it. During such periods the SDV 3100 HV may be muted, and may not respond to the controls. Please wait until the symbol disappears, then try again.
	Indicates a music track which can be played , or a playlist .
	Indicates a folder which conceals further folders or lists.
	Indicates that a source is being reproduced via a cable connection .
	Indicates that a source is being reproduced via a radio connection .
	Indicates that the SDV 3100 HV is reproducing a station or playing back a music track.
	Pause indicator
128 k 	Buffer display (fullness indicator, memory display) and data rate indicator (if available): The higher the data rate, the better the quality of reproduction.
 1:20	Display of the elapsed playback time. This information is not available for all services.
	Indicates that the  button can be used to switch to a higher menu or select level.
0 / 0	Position indicator in select lists. The first number shows the current position in the list, the second number the total number of list entries (length of list).
	Indicates that the selected menu item or list point can be activated by pressing the  button.
ABC 123 abc	or or Display of the symbol input modes
	Indicates the field strength of the radio signal.
	If the  symbol appears while playing back from a digital source or input - the SDV 3100 HV has switched over to its internal precision oscillator (local oscillator). This eliminates jitter effects, but is only possible if the clock quality of the connected signal is adequate.







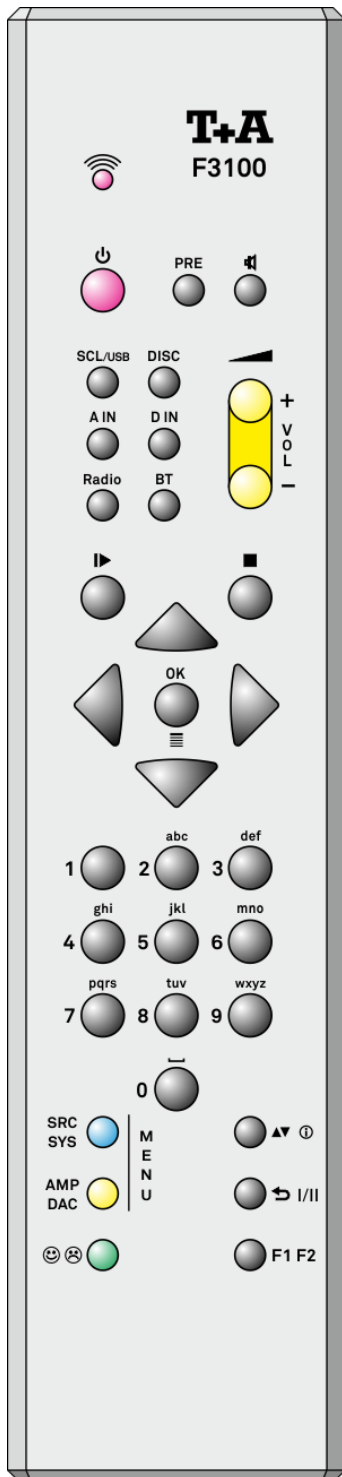



Remote control

Introduction

The following table shows the remote control buttons and their function when operating the machine.



	Switches the device on and off (red)
	Selects the SCL function (e.g. access to music servers, streaming services or similar) or the USB DAC function (playback from a connected computer), or selects the USB Media function (connected USB memory media) of the streaming client. Press this button repeatedly until the desired source appears on the screen.
	With the SDV 3100 HV connected, selects the IPA-Link input as the source.
	A brief press on this button selects the analogue input you wish to use. Press the button repeatedly until the desired input is displayed on the screen.
	A brief press on this button selects the digital input you wish to use. Press the button repeatedly until the desired input is displayed on the screen.
	Selects FM , DAB , or Internet radio as source. Press this button repeatedly until the desired source appears on the screen.
	Selects Bluetooth as source.
	Direct alpha-numeric input, e.g. track number, fast station select, radio station.
	The and buttons are also used for non-standard characters.
	During text input you can switch between numeric and alpha-numeric input, and between capitals and lower case by pressing the .
	Switches the speaker output of a connected HV-series device on and off.
	Switches the preamplifier output of the SDV 3100 HV on and off.
	Increase / decrease volume (yellow) The volume can be increased / decreased in steps by tipping one of the volume buttons. The current volume level is displayed on the display screen. If one of the buttons is kept pressed for approx.. 1 seconds the volume increases / decreases continuously until the button is released.
	Brief press: – Opens the Source menu (not available for all sources) Long press: – Opens the “ System configuration menu ” (see the chapter entitled ‘ Basic settings of the SDV 3100 HV ’)
	Long press: – Opens the “ DAC configuration menu ” (see the chapter entitled “ D/A-Converter settings of the SDV 3100 HV ”)

	<p>Brief press Returns to the previous point / change button</p> <p>Long press Fast rewind: searches for a particular passage. Tuner: Search</p>
	<p>Brief press Confirms the input / change button</p> <p>Long press Fast forward: searches for a particular passage. Tuner: Search</p>
	<p>Selects the next point within a list / select button Selects the next track / station during playback.</p>
	<p>Selects the previous point within a list / select button Selects the previous track / station during playback.</p>
	<p>Brief press Confirmation button during input procedures</p> <p>Long press Displays the Favourites list created on the SDV 3100 HV</p>
	<p>Starts playback (Play function) During playback: halts (Pause) or resumes playback</p>
	<p>Stops playback.</p> <p>During menu navigation: A brief press takes you back (higher) by one menu level or aborts the current input process; the change is then abandoned.</p>
	<p>Brief press Switches between capitals and lower case, and numeric / letters, when entering data.</p> <p>Long press Cycles through the various screen displays. Detailed display with / without CD text / Radiotext (if present) and large display with / without CD text / Radiotext (if present).</p>
	<p>Brief press When necessary, repeated presses of the button cycle through the various playback modes (repeat track, repeat all, etc.).</p> <p>Long press Switches between Stereo and Mono reception (only FM Radio)</p>
	<p>Brief press Adds a favourite to the Favourites list. System configuration menu: enables a source</p> <p>Long press Removes a favourite from the Favourites list. System configuration menu: disables a source</p>
	<p>Opens the D/A mode selection menu.</p>

The **SDV 31000 HV** can be controlled by the App too.

For Apple (iOS)



For Android





Basic settings of the SDV 3100 HV

System Configuration menu



In the System Configuration menu general device settings are adjusted. This menu is described in detail in the following chapter.

Calling up and operating the menu









- To call up the menu, briefly press the -button on the front panel or the -button on the remote control **F3100**.
- When you open the menu, the following Select points appear on the screen:

Adjustment facility			
D/A configuration	Select		
Source configuration	Select		
Analog output	Balanced	Unbalanced	
Headphone mode	Automatic	Manual	
Left rotary knob	Volume / Source	Source / Volume	
Display brightness	1	...	7
Display mode	Always on	Temporary	Always off
Language	Deutsch	English	Francaise further languages
Device name	SDV 3100 HV		
Energy Saver	On	Off	
Network	Configuration		
Music services	Configuration		
Bandwidth limit	No limit	2000 kbps	500 kbps
Device info	Display		

Using the front-panel controls:

- The **SELECT** knob is used to select any item within the menu system.
- To change a selected menu item, press the **SELECT** knob to confirm your choice, then adjust the value by rotating the knob.
- After making the adjustment, press the **SELECT** knob again to adopt the new setting.
- You can interrupt the process at any time by touching the  button; in this case any changes you have made are discarded.
- Holding the **SELECT** knob pressed in takes you one level further down in the menu system.
- Touch the  button again to quit the menu.

Using the remote control handset:

- Use the  /  buttons to select an item in the menu.
- If you wish to change a selected menu item, first press the -button, and then use the  / -buttons to alter it.
- After making the change, press the -button again to accept the new setting.
- You can press the -button at any time to interrupt the process; the change is then abandoned.
- Press the  button again to leave the menu.

D/A configuration menu item

This item opens the D/A Converter Settings menu. For details, refer to chapter "D/A converter settings of the SDV 3100 HV" (p. 22).

Source names
menu item

At this menu item you can activate and disable external sources, and assign a plain text name to each source; this name then appears in the screen displays.

When you call up this menu item using the  button, a list of all the external and internal sources of the **SDV 3100 HV** appears. Each source is followed by the assigned name, or if you have disabled the source concerned the note 'disabled'.

If you want to activate / disable a source, or change the plain text name, navigate to the appropriate line.

To activate a source, press the green  button; a long press on the green  button disables the source.

To change the plain-text name, move to the appropriate line and press the button. Now use the alpha-numeric keypad of the **F3100** to change the name as required, then confirm your choice with ; this saves the settings for that source.

The  button is used to switch between numeric and alpha-numeric input, and between capitals and lower-case letters.

Letters can be erased by pressing the -button.



The source name can only be changed for the external sources.

If you should wish to restore the factory default source name, erase the whole name before saving the empty field with the  button: this action resets the display to the standard source names.

The only available method of entering the name is to use the alpha-numeric keypad on the remote control handset.

sub point
Pass through

If you wish to connect a device with its own volume control (e.g. TV set), this menu point can be used to disable the volume control of the **SDV 3100 HV** for the **Analog IN 1** or **Analog IN 2** input (pass-through mode).



You should only select this setting if a device with its own volume control is connected to the unit. Ensure that the volume of the source device is turned down to zero before connecting it to the **SDV 3100 HV**, otherwise the speakers connected to it may be ruined through overloading.

Analog output
menu item

This menu item is used to set the type of connection used for the analog output. For RCA connection, select "Unbalanced" or "Balanced" for XLR connection.

Headphone mode
menu item

The **SDV 3100 HV** detects headphones automatically.

In the "**Automatic**" setting the pre-amplifier output is automatically switched off when headphones are connected. If you wish to be able to control these outputs separately, select the "**Manual**" setting.

Left rotary knob
menu item

Under this menu item you can define the main function of the left rotary knob. The set main function can be operated without pressing the knob first. For the second function, the knob must be pressed briefly first.

Select "**Volume/Source**" when volume control should be the main function or select "**Source/Volume**" if source selection is the main function.

Display Brightness
menu item
(screen brightness)

At this point you can adjust the brightness of the integral screen to suit your personal preference for normal use.



We recommend that brightness settings 6 and 7 should only be used when the screen is difficult to read due to very bright ambient light.

A lower brightness setting will extend the useful life of the screen.

Display Mode
menu item

This menu item offers the choice between three different display operation modes:

- Always on
- Temporary
- Always off

Selecting '**Temporary**' will switch the display is on for a short while each time the **SDV 3100 HV** is being operated. Shortly after operation the display will be switched off again automatically.



The brightness of the display can be adjusted separately with the menu item '**Display Brightness**' (see above).

Language
menu item

In this menu item you define the language to be used for the displays on the screen of the front panel of the **SDV 3100 HV**.

The language used for data transferred to the machine, e.g. from an Internet radio station, is determined by the supplying device or the radio station; you cannot define the language on the **SDV 3100 HV**.

Device name
menu item

This menu point can be used to assign an individual name to the **SDV 3100 HV**. In a home network the device then appears under this name. If an amplifier is connected via the **HLink** connection, then the amplifier is able to accept this name automatically, and display it on the screen.



The amplifier only accepts this name if an individual name has not already been assigned at the amplifier itself.

Energy Saver
menu item

The **SDV 3100 HV** features two stand-by modes: ECO Standby with reduced stand-by current drain, and Comfort Standby with additional functions, but slightly higher current drain. You can select your preferred stand-by mode in this menu point:

On (ECO standby):

Active functions in ECO standby mode:

- Power-on at the device itself.
Automatic power-down after ninety minutes without signal (only possible with certain sources).

Off (Comfort standby):

The following expanded functions are available:

- Unit can be switched on using the app.
- The automatic power-down function is disabled in Comfort standby mode.
- The picture and sound signals at the HDMI 1 and 2 sources are passed on to the connected TV even if the device is in standby mode.

Network
menu item

All network settings can be carried out at this menu point. For a detailed description on setting up a LAN or WLAN connection please also refer to the section entitled "**Network configuration**" on page 51.

Music services
menu item

At this point you can enter the access data for the music streaming services (TIDAL etc.) supported by the **SDV 3100 HV**.

Calling up this menu point by pressing the  button displays a list of the supported music services.

Select the service you wish to use, then confirm your choice with the  button.

Now use the alpha-numeric keypad of the **F3100** to enter the access data which you have received from your service provider in the lines "**User**" and "**Passphrase**".

Use the  button to switch between numeric and alpha-numeric input, and between capitals and lower-case letters.

Press the  button to erase any letter.

In each case confirm your input of user name and password by pressing the  button.

To conclude the procedure and save the data, select the menu entry “**Store and exit?**” and confirm by pressing the  button.

 If access data for the selected music service has already been stored, the new data will overwrite them. To use the new access data you must first perform a “Logout” for the service in question, then switch the **SDV 3100 HV** off and on again.

 The music streaming services supported by the **SDV 3100 HV** require a subscription to the appropriate service provider.

Bandwidth limit menu item

This menu point can be used to adjust the link speed of the Internet connection. The bitrate of the Internet radio stations and streaming services is adjusted automatically to match your chosen setting. If you select “**no limit**” for bandwidth limit, the highest available quality is always selected automatically.

 If you do not know the exact bandwidth of the internet connection, we recommend that you select the setting at which no drop-outs occur during playback.

Device Info menu item

At this menu point you will find information on the status of the installed software and the factory reset.

Sub-point Update

At this point it is possible to initiate a firmware update.

Sub-point Update package

This point displays the currently installed software package.

Sub-point Control

Display of the control software version

Sub-point Client

Display of the Streaming Client software version

Sub-point DAB / FM

Display of the tuner software version.

Sub-point Bluetooth

Display of the Bluetooth module software

Sub-point DSP

Display of the DSP-processor software

Sub-point Default settings

Calling up and confirming this menu point erases all personal settings, and restores the machine to the state as delivered (factory defaults).

Sub-point Legal information

Information on accessing the legal information and license notices.

 For further information, see the chapter entitled “**Legal Information**”.

D/A-Converter settings of the SDV 3100 HV



A number of special settings are available for the **SDV 3100 HV** D/A converter; they are designed to fine-tune the characteristics of your amplifier to suit your listening preferences.. This settings are described in detail in the following chapter.

Calling up and operating the menu

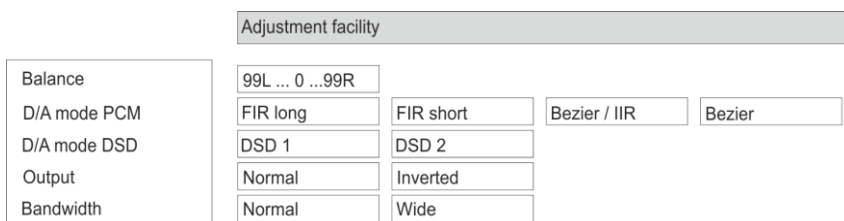





- To call up the menu, press and hold the **AMP/DAC** button on the **F3100**.
- To call up the menu on the front panel, touch the  button and select the menu item "D/A configuration" with the **SELECT** knob and press it to access the menu.
- When you open the menu, the following Select points appear on the screen:



Using the front-panel controls:

- The **SELECT** knob is used to select any item within the menu system.
- To change a selected menu item, press the **SELECT** knob to confirm your choice, then adjust the value by rotating the knob.
- After making the adjustment, press the **SELECT** knob again to adopt the new setting.
- You can interrupt the process at any time by touching the  button; in this case any changes you have made are discarded.
- Holding the **SELECT** knob pressed in takes you one level further down in the menu system.
- Touch the  button again to quit the menu.

Using the remote control handset:

- Use the  /  buttons to select an item in the menu.
- If you wish to change a selected menu item, first press the -button, and then use the  / -buttons to alter it.
- After making the change, press the -button again to accept the new setting.
- You can press the -button at any time to interrupt the process; the change is then abandoned.
- Press the **AMP/DAC** button again to leave the menu.

<p>set-up option Balance</p>	<p>This menu point is used to alter the balance in level between the left and right channels, e.g. to compensate for non-symmetrical loudspeaker positioning. The balance can be adjusted in increments of 1 dB; the screen always displays the current value.</p>
<p>set-up option PCM D/A mode (PCM playback only)</p>	<p>i This menu item is displayed according to the format currently being played. This means that the DSD D/A mode can be selected during DSD playback and the oversampling types can be selected during PCM playback.</p> <p>The SDV 3100 HV can exploit four different filter types offering different tonal characters:</p> <ul style="list-style-type: none"> • OVS long FIR (1) is a classic FIR filter with an extremely linear frequency response. • OVS short FIR (2) is a FIR filter with improved peak handling. • OVS Bezier / FIR (3) is a Bezier interpolator combined with a IIR filter. This process produces a result very similar to an analogue system. • OVS Bezier (4) is a pure Bezier interpolator – offering perfect “timing” and dynamics.
<p>set-up option DSD D/A mode (DSD playback only)</p>	<p>i Please refer to the Chapter 'Technical description - Digital filters / Oversampling' for an explanation of the different filter types.</p> <p>The SDV 3100 HV offers two different converter modes for DSD playback.</p> <ul style="list-style-type: none"> • DSD 1 • DSD 2
<p>set-up option Output</p>	<p>With particular instruments or voices the human ear is certainly capable of detecting whether absolute phase is correct or not. However, absolute phase is not always correctly recorded.</p> <p>In this menu item the phase of the signal can be changed from normal to inverse phase and back.</p> <p>i The correction is carried out at the digital level, and has absolutely no adverse effect on sound quality.</p>
<p>set-up option Bandwidth</p>	<p>In this menu item, the bandwidth of the analogue output filter can be switched between 60 kHz (normal mode) or 120 kHz ('WIDE' mode). The 'WIDE' setting allows a more spacious music reproduction.</p> <p>i Please refer to the Chapter 'Technical description - Digital filters / Oversampling' for an explanation of the different filter types.</p>

Operating the source devices in detail

Operation with the F3100 remote control

The operation of the source devices is described in the following chapters using the **F3100** remote control because only with this remote control all functions of this device can be operated (e.g. adding favourites).

Operation with controls on the front panel of the device

The front panel controls can be used to operate the basic functions of the **SDV 3100 HV**.

The **SELECT** knob can be used to navigate through lists and menus or to control the Disc- player in the same way as the cursor and OK buttons of the **F3100** remote.

In Lists

- Choose a list or menu item by turning the **SELECT** knob.
- By pressing the **SELECT** knob you can select an item or start playback of a title or station.
- By pressing the **SELECT** knob for a longer time you can leave a submenu or navigate to the parent menu level (**BACK**).

Favourites lists

General information

The **SDV 3100 HV** includes the facility to create Favourites lists. The purpose of these lists is to store radio stations and podcasts, so that they can be accessed swiftly.

Each of the sources **FM radio**, **DAB radio**, and **Internet radio** (incl. podcasts) features its own Favourites list.

Once stored, the favourites can either be selected from the Favourites list, or called up directly by entering the program location number. The option of selecting using the location number is particularly useful when you wish to call up favourites when the screen is not in view (e.g. from an adjacent room) or using a house control system.

i Favourites lists for the various music services (TIDAL etc.) are not supported. Instead it is usually possible to add Favourites and Playlists on-line via the provider's account. These can then be called up and played via the **SDV 3100 HV**.

- Calling up the Favourites list

- The first step is to switch to one of the sources listed above.
- Call up the Favourites list by a long press on the **OK** button on the **F3100** remote control or by a brief press on the **☰** button on the **SDV 3100 HV's** front panel.

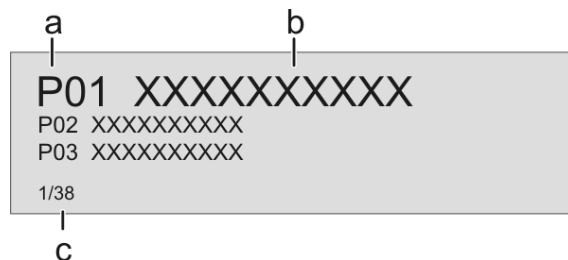

- a) Here the program location number is displayed within the list. Since it is possible to erase individual list items, the numbering may not be continuous.
- b) The selected list entry is displayed in enlarged form.
- c) Position display in the Favourites list.

Adding a favourite

i If you especially enjoy the piece of music or radio station to which you are currently listening, simply press the green **😊☹️**-button on the **F3100**; this action stores the station in the corresponding Favourites list.

i Each Favourites lists features 99 program locations.
Favourites lists can only be used to store the piece of music and station which is currently playing.





Erasing a favourite from the Favourites list

Call up the Favourites list by a long press on the **OK** button on the **F3100** remote control or by a brief press on the **☰** button on the **SDV 3100 HV's** front panel.

Use the **▲** / **▼** buttons to select the station in the list which you wish to erase, then hold the green **😊☹️** button pressed in; this action removes the item from the Favourites list.



i Erasing a Favourite does not cause the following Favourites to move up the list. The station position is no longer displayed after erasure, but a new Favourite can still be assigned to it.

Selecting a favourite from the list

- Call up the Favourites list.
- Use the  /  buttons to select a stored item from the Favourites list. The selected favourite is displayed in enlarged form.
- Select the favourite to be played by pressing the  or  button.
- You can return to the station to which you are currently listening (quit) by pressing the  button.

Directly selecting a favourite



In addition to the option of selecting favourites using the Favourites list, it is possible to access the desired favourite directly by entering the program location number.

To select a stored favourite directly during playback, enter the two-digit program location number of the new favourite using the numeric buttons  (to)  on the remote control handset.



After you have pressed the numeric buttons, playback switches to the favourite you have just selected.

Sorting Favourites lists

The sequence of items in the Favourites list you have created can be altered in any way you wish. This is the procedure for changing the order of the list:

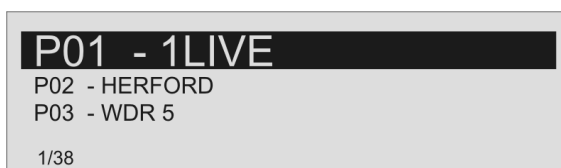
- The first step is to call up the Favourites list.
- Use the  /  buttons to select the favourite whose position you wish to change. The selected Favourite is displayed in enlarged form.
- Pressing the  button activates the Sort function for the selected favourite. The favourite is highlighted on the screen.



- Now move the activated favourite to your preferred position in the Favourites list.
- A further press on the  button de-activates the Sort function, and the favourite is stored at the new position.
- To close the Favourites list, press and hold the  button on the **F3100** or briefly press the  button on the **SDV 3100 HV**.



If you have previously erased a number of favourites, you may well find that some program locations in the Favourites list are missing (empty). Nevertheless, the favourites can still be moved to any location in the list!

Operating the radio

The **MP 3100 HV** features an **FM Tuner** (VHF radio) with HD Radio™ technology*, a **DAB / DAB+** reception section (digital radio) and also includes the facility to stream **Internet radio**. The following section describes in detail how to operate the individual radio sources.

HD Radio technology enables radio stations to transmit analogue and digital programmes on the same frequency simultaneously.

The integral DAB+ receiving section is backwards-compatible with DAB, to ensure that you have access to a wide range of stations.

*HD Radio™ technology only available in US-version.

FM – Radio

Selecting FM radio

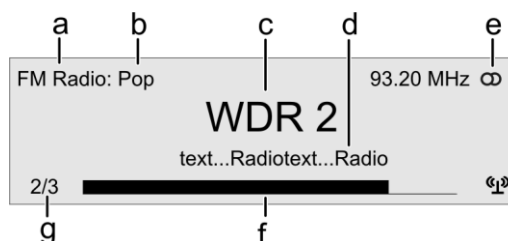

Select the source "**FM Radio**" with the source selection button  on the **F3100** or by turning the **SOURCE / VOLUME** knob on the front panel of the **SDV 3100 HV**.

Display



- Displays the type of reception currently in use.
- Hear the music type or style is displayed, e.g. Pop Music.
This information is only displayed if the transmitting station broadcasts it as part of the *RDS* system. If you are listening to a station which does not support the *RDS* system, or only supports it in part, these information fields remain empty.
- The frequency and / or the station name is displayed in enlarged form. If a station name is displayed, its frequency is shown in area 'e'.
- These lines display information which is broadcast by the station (e.g. Radiotext).
- Display of Stereo '🔊' / Mono '●'
- The *field strength*  and therefore the reception quality to be expected from the set transmitting station can be assessed from the field strength.
- FM Radio**: when receiving an HD Radio broadcast, the screen displays the currently selected programme from the total number of programmes available, e.g. programme 2 of total 3 available.

Manual station search

Holding one of the  /  buttons pressed in initiates a station search for FM tuner in the upward or downward direction. The station search stops automatically at the next station.

As soon as the station is audible, you can add it to your Favourites list by pressing the  button.

Operation on the front panel



It is also possible to select a frequency directly, by rotating the knob on the machines front panel. By pressing the **SELECT** knob, repeatedly if necessary, the following operation modes can be temporary selected: The currently selected operating mode is shown on the left side of the display.

Display indicator	Function
Freq	Manual frequency selection
Fav	Selects a favourite from the list
No display (standard setting)	Selects a station from the complete station list

Searching for an HD Radio station

The method of searching for an HD Radio station is the same as for an analogue FM station search. As soon as you select a station with a HD Radio programme, playback automatically switches to the digital programme.

As soon as the **SDV 3100 HV** is playing an HD Radio broadcast, the display of reception mode in area “a” (see illustration: FM Radio display) switches to “HD Radio”, while screen area “g” shows the number of available stations, e.g. “1/4” (First HD Radio programme selected from 4 available).



You can switch between the available HD Radio programmes using the  /  buttons.

Operation on the front panel

It is also possible to select a frequency directly, by rotating the knob on the machine's front panel. By pressing the **SELECT** knob, repeatedly if necessary, the following operation modes can be temporarily selected:

Display indicator	Function
Fav	Selects a favourite from the list
HD	HD Radio programme selection (if available)
Freq	Manual frequency selection
No display	Selects a station from the complete station list

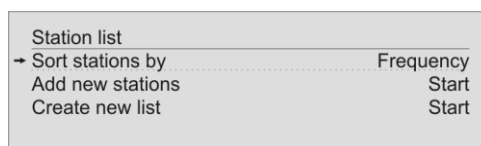

Automatic station search

A long press on the  button on the front panel or a brief press on the  button on the **F3100** calls up the Station list menu. The following Select points are available:





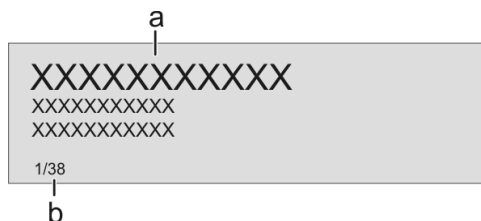

- If you wish to create a new station list, select the item “**Create new list**” and confirm your choice with .
- The station search begins, and automatically searches for all radio stations which the machine is able to pick up.
- If you wish to update an existing list, select the item “**Add new stations**”.
- The menu item “**Sorting by ...**” allows you to sort the stored list by any of several criteria.

Selecting a station from the Station list

- Pressing the  /  buttons on the **F3100** or rotating the **SELECT** knob on the front panel opens the list of all stored stations.



- Select one of the stored stations with the  /  buttons or by rotating the **SELECT** knob. The station you choose is now displayed in enlarged form. Press the  or  button to select the enlarged station for playing. Pressing the  button returns you to the station to which you are currently listening (quit).
- Position indicator in the Favourites list.



Stations to which you often listen can be stored in a Favourites list; this makes it easier to select them (see the section entitled “**Favourites list**”).

RDS functions

i If the station being received is broadcasting relevant RDS data, the following information will be displayed on the screen:

- **Station name**
- **Radiotext**
- **Program Service Data (PSD)***

For stations that do not support the RDS system or only partially or with weak reception, no information will be displayed.

* Only possible when receiving HD Radio transmissions.

Switching Radio Text on and off

The Radio text function can be switched on and off by long presses on the  button on the remote control handset. Repeatedly if necessary.

i HD Radio stations are also capable of transmitting what is known as PSD information (e.g. track and performer) in addition to Radiotext. As soon as an HD Radio station is picked up, you can cycle through the following operational states by repeatedly pressing the  button:

Radiotext on → PSD information → Radiotext off

If the radio station is not transmitting Radiotext or PSD information, the display remains blank.

Mono / Stereo (only FM – Radio)

You can toggle the radio of the **SDV 3100 HV** between stereo and mono reception by a long press on the  button on the **F3100**. The reception mode is shown on the screen by the following symbols:

'●' (Mono) or '∞' (Stereo)

If the station you wish to listen to is very weak or very distant, and can only be picked up with severe background noise, you should always switch to MONO mode as this reduces the unwanted hiss significantly.

i The Mono and Stereo symbols are only shown in the detailed screen display.

DAB - Radio

Selecting DAB radio

Select the source "**DAB Radio**" with the source selection button  on the **F3100** or by turning the **SOURCE / VOLUME** knob on the front panel of the **SDV 3100 HV**.

i Depending on the frequency band (block), it may take up to two seconds to switch stations when in **DAB mode**.

Display

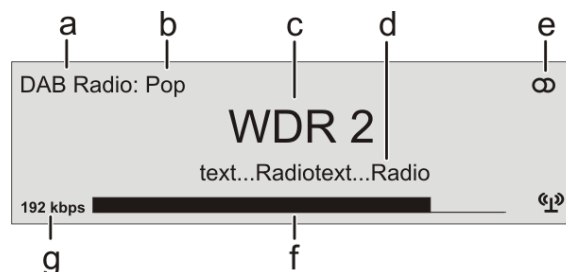



a) Displays the type of reception currently in use.

b) Hear the music type or style is displayed, e.g. Pop Music.

This information is only displayed if the transmitting station broadcasts it as part of the *RDS* system. If you are listening to a station which does not support the *RDS* system, or only supports it in part, these information fields remain empty.

- c) The frequency and / or the station name is displayed in enlarged form. If a station name is displayed, its frequency is shown in area 'e'.
- d) These lines display information which is broadcast by the station (e.g. Radiotext).
- e) Display of Stereo " ".
- f) The field strength (q) and therefore the reception quality to be expected from the set transmitting station can be assessed from the field strength.
- g) Bit-rate of the broadcasting station when listening to DAB radio.
 - * The higher the bit-rate, the better the station's sound quality.

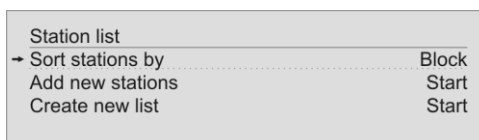

Automatic station search

A long press on the  button on the front panel or a brief press on the  button on the **F3100** calls up the Station list menu. The following Select points are available:







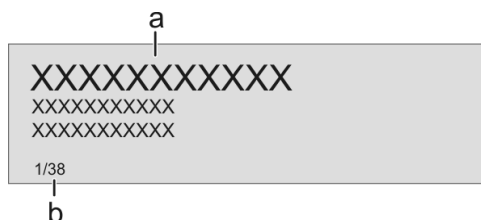

- If you wish to create a new station list, select the item **“Create new list”** and confirm your choice with .
- The station search begins, and automatically searches for all radio stations which the machine is able to pick up.
- If you wish to update an existing list, select the item **“Add new stations”**.
- The menu item **“Sorting by ...”** allows you to sort the stored list by any of several criteria.

Selecting a station from the Station list

- Pressing the  /  buttons on the **F3100** or rotating the **SELECT** knob on the front panel opens the list of all stored stations.



- a) Select one of the stored stations with the  /  buttons or by rotating the **SELECT** knob. The station you choose is now displayed in enlarged form.
 - Press the  or  button to select the enlarged station for playing.
 - Pressing the  button returns you to the station to which you are currently listening (quit).
- b) Position indicator in the Favourites list.

 Stations to which you often listen can be stored in a Favourites list; this makes it easier to select them (see the section entitled **“Favourites list”**).

RDS functions

 If the station being received is broadcasting relevant RDS data, the following information will be displayed on the screen:

- **Station name**
- **Radiotext**
- **Program type (genre)**

For stations that do not support the RDS system or only partially or with weak reception, no information will be displayed.

Internet Radio source (Streaming www)

Selecting Internet Radio as source

First choose **Internet Radio** as listening source by pressing the **RADIO** - button on the **F3100** or by turning the **SOURCE / VOLUME** -Knob on the front panel of the **SDV 3100 HV**.

Selecting podcasts

Select the “**Podcasts**” entry instead of the “**Internet Radios**”.

i The method of operating music services is described separately in the section entitled “**Operating music services**”.

Playback

The music content to be played is selected with the help of Select lists. These lists are controlled using the navigation buttons (cursor buttons) on the remote control handset or by the **SELECT** knob on the machine’s front panel.

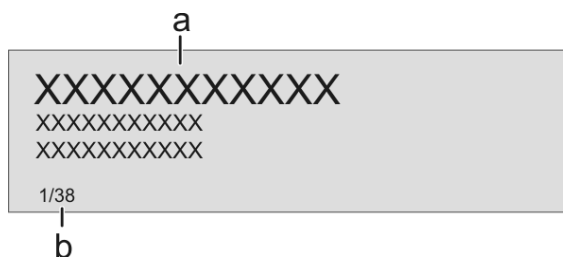

a) Select one of the stored stations with the **▲** / **▼** buttons (or by rotating the **SELECT** knob). The station you choose is now displayed in enlarged form.

A brief press selects the previous / next entry within the list. The scrolling speed can be increased by holding the button pressed.

The list entry you choose is now displayed in enlarged form.

Press the **▶** or **OK** button to open or start the list entry shown in enlarged form.

Pressing the **◀** button returns you to the previous folder level.

b) Indicates the currently selected point within the opened list.

Starting playback

Press the **▶** button on the remote control handset or the machine’s front panel to start playback.

Stopping playback

Pressing the **■** button halts playback.

Favourites list

Stations and podcasts to which you often listen can be stored in a Favourites list; this makes it easier to select them (see the section entitled “**Favourites list**”).

Front panel display









While playing back the **SDV 3100 HV** can be switched to either of two different screen displays with a long press on the  button:

- **Large-format display:**
Enlarged display of the most important information, clearly legible even from a distance
- **Detail display:**
Small-text display showing a large number of additional information points, e.g. bit-rate etc.

Search function

The Search function provides a means of locating Internet radio stations swiftly.

This is the procedure for searching for a particular Internet radio station:

- Use the  /  buttons to select the “**Search**” item, and confirm your choice by pressing the  button or while navigating within lists alternatively call up the search function by pressing the  button.
- You will now see a window in which you can enter the keyword using the remote control handset’s alpha-numeric keypad.
- Press the  button to erase any letter.
- Briefly press the  button to start the search.
- After a short delay you will see a list of the search results.



The search function can be called up from every point within the lists by pressing the  button.

Search strings can consist of up to eight characters. It is also possible to enter multiple keywords separated by a space character, e.g. “BBC RAD1”.

To search for a podcast, select the “Search” entry under “Podcasts”.

Operating music services

General information

The **SDV 3100 HV** supports playback of music services such as TIDAL. To make use of music services you may need to take out a paid subscription with the appropriate provider.

Use of music services requires the input of access data (username and password). These access data can be stored separately for each provider in the “Music services” menu within the System Configuration menu (see the section entitled “**Basic settings of the SDV 3100 HV**”).

 Future music services and others which are not currently supported may be added subsequently by updates to the firmware of the **SDV 3100 HV**.





Selecting a music service

First choose the desired music service as listening source by pressing the **(SCL / USB)**-button on the **F3100** or by turning the **SOURCE / VOLUME** -Knob on the front panel of the **SDV 3100 HV**.

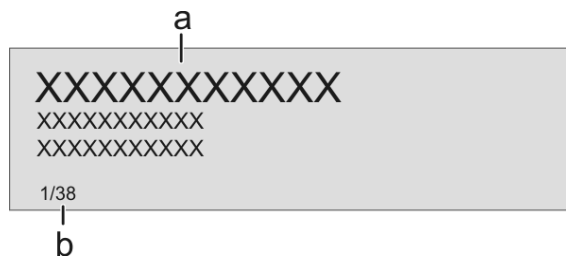
Playback

The music content to be played is selected with the help of Select lists. These lists are controlled using the navigation buttons (cursor buttons) on the remote control handset or by the **SELECT** knob on the machine’s front panel.



- a) Use the  /  buttons to select the desired entry from the list.
A brief press selects the previous / next entry within the list. The scrolling speed can be increased by holding the button pressed.
The list entry you choose is now displayed in enlarged form.
Press the  or  button to open or start the list entry shown in enlarged form.
Pressing the  button returns you to the previous folder level.
- b) Indicates the currently selected point within the opened list.



Starting playback

Press the  button on the remote control handset or the machine's front panel to start playback.

Stopping playback

Pressing the  button halts playback.



Skipping tracks

A brief press on the  /  buttons during playback causes the device to jump to the next or previous piece of music within the current playlist.

 The exact form of the displayed list and the preparation of the content depend to a large extent on the music service provider. You may therefore find that in some cases not all the functions described in these instructions can be used.

Search function

In order to find quickly what you want in the wide range of services on offer, it is possible to search for specific items in the content available from music service providers.

The first step in the procedure is to open the Select list of the appropriate music service. Navigate to the "Search" entry, and confirm by pressing the  button. As an alternative it is possible to call up the search function by pressing the  button while navigating in lists.



A window now opens in which the keyword can be entered using the remote control handset's alpha-numeric keypad.

Press the  button to erase any letter.

Start the search by briefly pressing the  button.

After a short delay a list appears showing the search results.

The results list varies from one music service to another. Many services allow you to filter the search results by artiste, album or track once the search has been completed.

 The search function can be called up from every point within the lists by pressing the  button.

 The search strings can consist of up to eight characters. It is also possible to enter multiple keywords separated by a space character, e.g. "The Beatles".



Playlists and favourites

Most music services offer the facility to register on the provider's website with the user data, create dedicated playlists, and manage the lists conveniently.

Once created, the playlists appear in the Select list of the corresponding music service, where they can be called up and played via the **SDV 3100 HV**.

The location within the select list at which the playlists can be accessed varies from one music service to another. Often these folders are named "My music", "Library", "Favourites" or similar.

Front panel display

 While playing back the **SDV 3100 HV** can be switched to either of two different screen displays with a long press on the  button:

- **Large-format display:**
Enlarged display of the most important information, clearly legible even from a distance
- **Detail display:**
Small-text display showing a large number of additional information points, e.g. bit-rate etc.

Operating the UPnP / DLNA source (Streaming Client)

General information on the streaming client

The **SDV 3100 HV** features what is known as a 'streaming client'. This facility makes it possible to play music files stored on PCs or servers (NAS) within the network.

The media content formats which the **SDV 3100 HV** can reproduce are very wide-ranging, and extend from compressed formats such as MP3, AAC and OGG Vorbis to high-quality non-compressed data formats such as FLAC, ALAC, AIFF and WAV, which are thoroughly audiophile in nature. A full listing of all possible data and playlist formats is included in the Specification, which you will find in the Appendix to these instructions.

Since virtually no read or data errors occur when electronic memory media are accessed, the potential reproduction quality is even higher than that of CD. The quality level may even exceed that of SACD and DVD-Audio.

Selecting the UPnP / DLNA source

Choose "UPnP / DLNA" as listening source by pressing the **(SCL / USB)**-button on the **F3100** (repeatedly if necessary), until the source "UPnP / DLNA" is displayed on the screen. or by turning the **SOURCE / VOLUME** -Knob on the front panel of the **SDV 3100 HV**.

Playback

The music content to be played is selected with the help of Select lists. These lists are controlled using the navigation buttons (cursor buttons) on the remote control handset or by the SELECT knob on the machine's front panel.

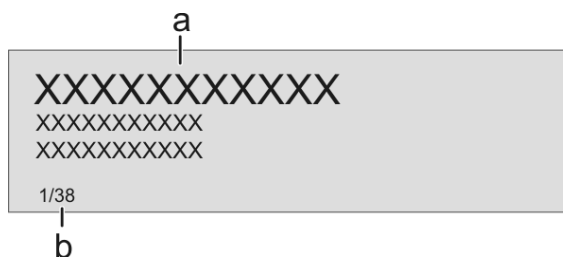

- a) Use the **(▲)** / **(▼)** buttons to select the desired entry (Server / Folder / Track) from the list.

A brief press selects the previous / next entry within the list. The scrolling speed can be increased by holding the button pressed.

The list entry you choose is now displayed in enlarged form.

Press the **(▶)** or **(OK)** button to open or start the list entry shown in enlarged form.

Pressing the **(◀)** button returns you to the previous folder level.

- b) Indicates the currently selected point within the opened list.



The exact form of the displayed list and the preparation of the content also depend to a large extent on the capabilities of the server, i.e. the full facilities of the **SDV 3100 HV** cannot be exploited with all servers or media. You may therefore find that in many cases not all the functions described in these instructions can be used.



Starting playback

Press the  button on the remote control handset or the machine's front panel to start playback.

Stopping playback

Pressing the  button halts playback.

Skipping tracks



A brief press on the  /  buttons during playback causes the device to jump to the previous or next piece of music within the current playlist.

Playback of directories

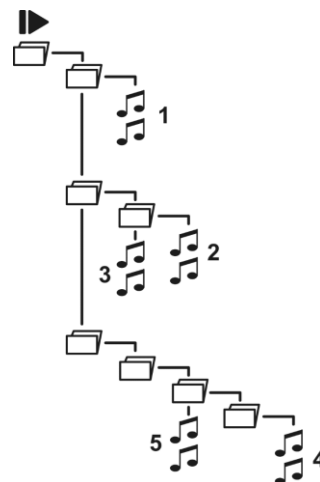
In addition to the facility to play back individual folder content, it is also possible to play back entire directories. This is accomplished by selecting the folder of the directory to be played, then pressing the  button to start playback. Playback commences with the first entry in the list of content to be played. If an entry in the list should contain a folder with additional sub-folders, the content of the lowest folder is always played first. This is followed by the content of the next higher folder level, etc. (see diagram right).



Search function

When you are navigating through lists you can call up the **SDV 3100 HV**'s letter search function at any time by briefly pressing the  button. The screen now displays the message "Search". While this is on the screen, enter up to eight letters or numerals using the remote control handset; the letters assigned to the numeric buttons are printed below the buttons. To obtain a particular letter, press the appropriate button repeatedly until the correct letter appears on the screen. Before entering the next character you have to wait until the cursor is displayed again. Press the  button to erase any letter.

After pressing the  button or after a brief delay with no further input the **SDV 3100 HV** moves to the first entry in the list which starts with the characters you entered.



If the text searched for is not found the best matching result will be shown. You can abort the search using the -button.

The function searches only the current folder. Eventually existing subfolders are ignored.

Front panel display



The **SDV 3100 HV** provides different screen displays for the UPnP/DLNA source.

A long press on the -button on the remote control handset is used to switch between the display modes.

- **Large-format display:**
Enlarged display of the most important information, clearly legible even from a distance
- **Detail display:**
Small-text display showing a large number of additional information points, e.g. bit rate etc.

Playing USB memory media

(USB Media source)

General information

The **SDV 3100 HV** is capable of playing music files stored on USB memory media, and features two USB sockets for this purpose: **USB IN** on the machine's front panel, and **USB HDD** on the back panel.



The memory medium can be formatted with any of the following file systems: FAT16, FAT32, NTFS, ext2, ext3 or ext4.

It is also possible to power the USB memory medium via the USB socket, provided that the unit's current drain accords with the USB norm. Normed 2.5 inch USB hard discs can be connected to the socket directly, without requiring their own mains PSU.

Selecting USB Media as source

First choose **USB Media** as listening source by opening the source selection menu on the **F3100** remote by pressing the **(SCL/USB)**-button or by turning the **SOURCE**-Knob on the front panel of the **SDV 3100 HV**.

All USB memory media connected to the machine are now displayed. If no USB memory medium is found, the screen displays the message "**No data available**".

Playback

The music content to be played is selected with the help of Select lists. These lists are controlled using the navigation buttons (cursor buttons) on the remote control handset or by the **SELECT** knob on the machine's front panel.

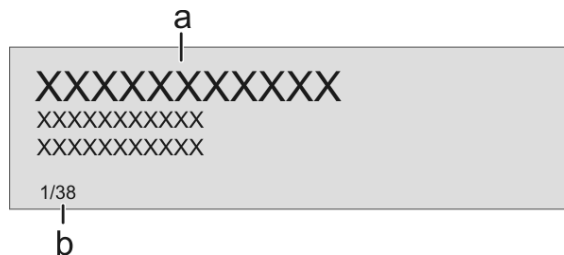

- a) Use the / buttons to select an (a) **USB memory / folder / track** from the list.

A brief press selects the previous / next entry within the list. The scrolling speed can be increased by holding the button pressed.

The list entry you choose is now displayed in enlarged form.

Press the or button to open or start the list entry shown in enlarged form.

Pressing the button returns you to the previous folder level.

- b) Indicates the currently selected point within the opened list.

Starting playback

Press the button on the remote control handset or the machine's front panel to start playback.

Stopping playback

Pressing the button halts playback.

Skipping tracks



A brief press on the / buttons during playback causes the device to jump to the previous or next piece of music within the current playlist.

Playback of directories

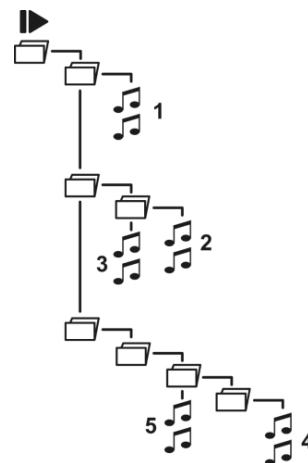
In addition to the facility to play back individual folder content, it is also possible to play back entire directories. This is accomplished by selecting the folder of the directory to be played, then pressing the  button to start playback. Playback commences with the first entry in the list of content to be played. If an entry in the list should contain a folder with additional sub-folders, the content of the lowest folder is always played first. This is followed by the content of the next higher folder level, etc. (see diagram right).



Search function

When you are navigating through lists you can call up the **SDV 3100 HV's** letter search function at any time by briefly pressing the  button. The screen now displays the message "Search". While this is on the screen, enter up to eight letters or numerals using the remote control handset; the letters assigned to the numeric buttons are printed below the buttons. To obtain a particular letter, press the appropriate button repeatedly until the correct letter appears on the screen. Before entering the next character you have to wait until the cursor is displayed again. Press the  button to erase any letter.

After pressing the  button or after a brief delay with no further input the **SDV 3100 HV** moves to the first entry in the list which starts with the characters you entered.



If the text searched for is not found the best matching result will be shown. You can abort the search using the -button.

The function searches only the current folder. Eventually existing subfolders are ignored.

Front panel display



While playing USB memory media the **SDV 3100 HV** can be switched to either of two different screen displays with a long press on the button:

- **Large-format display:**
Enlarged display of the most important information, clearly legible even from a distance
- **Detail display:**
Small-text display showing a large number of additional information points, e.g. bit-rate etc.

Operating the Bluetooth source

The **SDV 3100 HV**'s integral Bluetooth interface provides a means of transferring music wirelessly from devices such as smart-phones, tablet PCs, etc. to the **SDV 3100 HV**.

 For a successful audio Bluetooth transfer from a mobile device to the **SDV 3100 HV** the mobile device must support the A2DP Bluetooth audio transfer protocol.

Selecting the Bluetooth Audio source

First choose **BLUETOOTH** as listening source by opening the source selection menu on the **F3100** remote by pressing the -button or by turning the **SOURCE**-Knob on the front panel of the **SDV 3100 HV**.

Setting up audio transfer

Before music from a Bluetooth-capable device can be played through the **SDV 3100 HV**, the external device must first be registered to the **SDV 3100 HV**. As long as the **SDV 3100 HV** is switched on and no device is connected, it is always ready to receive. In this state the screen displays the message 'not connected'.

This is the procedure for establishing a connection:

- Start a search for Bluetooth equipment on your mobile device.
- When it finds the **SDV 3100 HV**, make the connection to your mobile device.

Once the connection is successfully established, the message on the **SDV 3100 HV**'s screen switches to 'connected to *YOUR DEVICE*'.

 If your device requests a PIN code, this is always '0000'.

 The procedure for establishing a connection can only be made if the Bluetooth source is activated (see chapter "**Basic settings of the SDV 3100 HV**").

 Due to the large number of different equipment on the market, we are only able to provide a general description for setting up the radio connection. For detailed information please refer to the operating instructions supplied with your device.

Playback functions

Information on the piece of music currently being played is displayed on the screen of the **SDV 3100 HV** if this function is supported by the device connected to the unit.

The behaviour and method of operating the connected mobile device are determined by the device itself. In general terms the function of the buttons of the **SDV 3100 HV** or the **F3100** remote control handset are as follows:



Start and pause playback

The  / buttons on the remote control handset or the front panel are used to start and pause playback (PLAY / PAUSE function).

Stop playback

Pressing the  button halts playback.

Skipping tracks

A brief press on the  /  buttons during playback causes the device to jump to the next or previous piece of music within the current playlist.

 Please note that many AVRCP-capable mobile devices do not support the controlling through the **SDV 3100 HV**. In case of doubt, please ask the manufacturer of your mobile device.

Controlling the SDV 3100 HV

The **SDV 3100 HV** can also be controlled from the mobile device (Start/Stop, Pause, Volume, etc.). To control the **SDV 3100 HV** the mobile device must conform to the Bluetooth AVRCP protocol.

 Please note that many AVRCP-capable mobile devices do not support all the **SDV 3100 HV**'s control functions. In case of doubt, please ask the manufacturer of your mobile device.

NOTES

 The **SDV 3100 HV** has been tested with a large number of Bluetooth-capable mobile devices. However, we are unable to guarantee general compatibility with all devices available commercially since the range of equipment is so wide, and the various implementations of the Bluetooth standard differ widely in some cases. If you encounter a problem with Bluetooth transfer, please contact the manufacturer of the mobile device.

The maximum range of a Bluetooth audio transfer is normally about 3 to 5 metres, but the effective range may be affected by a number of factors. To achieve good range and interference-free reception there should be no obstacles or persons between the **SDV 3100 HV** and the mobile device.

Bluetooth audio transfers take place in what is known as the “everyman frequency band”, in which many different radio transmitters operate - including WLAN, garage door openers, baby intercoms, weather stations, etc. Radio interference caused by these other services may cause brief dropouts or - in rare cases - even failure of the connection, and such problems cannot be excluded. If problems of this kind occur frequently in your environment, we recommend that you use the Streaming Client or the USB input of the **SDV 3100 HV** instead of Bluetooth.

By their nature, Bluetooth transmissions always involve data reduction, and the attainable sound quality varies according to the mobile device in use, and the format of the music to be played. As a basic rule the maximum quality of music which is already stored in a data-reduced format, such as MP3, AAC, WMA or OGG-Vorbis, is worse than with uncompressed formats such as WAV or FLAC. For the highest reproduction quality we always recommend the use of the Streaming Client or the USB input of the **SDV 3100 HV** instead of Bluetooth.



Qualcomm is a trademark of Qualcomm Incorporated, registered in the United States and other countries, used with permission. aptX is a trademark of Qualcomm Technologies International, Ltd., registered in the United States and other countries, used with permission

The SDV 3100 HV as D/A Converter

General Information

The **SDV 3100 HV** can be used as a high-quality D/A converter for other devices such as computers, streamer, digital radios etc. which are fitted with poor-quality converters or no converter at all. The **SDV 3100 HV** features two optical, five electrical **S/P-DIF** digital inputs and two **HDMI**-inputs on the back panel to allow this usage.

Two **USB-DAC** inputs on the back panel permits to use the **SDV 3100 HV** as D/A converter for computers.

S/P-DIF (Digital IN 1 ... IN7)

You can connect devices with electrical co-axial, BNC, AES-EBU or optical output to the digital inputs of the **SDV 3100 HV**. At inputs DIGITAL IN 1 to DIGITAL IN 7 the **SDV 3100 HV** accepts digital stereo signals conforming to the S/P-DIF norm, with sampling rates of 32 to 192 kHz.

HDMI

At the **HDMI 1** and **HDMI 2** inputs, the **SDV 3100 HV** accepts digital PCM encoded stereo signals with sampling rates of 44.1 ... 384 kHz (32 bit) and DSD data with a sampling rate of DSD64.

If a TV is connected to the **HDMI OUT** output, the TV sound can be transmitted to the **SDV 3100 HV** via ARC (Audio Return Channel) if supported by the TV.

If necessary, the **SDV 3100 HV** can be switched to By-Pass mode by a long press on the  button. In this case, the sound is played back on the TV.

 To use the ARC function, the TV must support it and the **SDV 3100 HV** must be connected to an ARC compatible input.

USB DAC

At the **USB DAC** inputs the **SDV 3100 HV** accepts digital PCM-encoded stereo signals with sampling rates of 44.1 to 384 kHz (32-bit) and DSD data with sampling rates of DSD64, DSD128, DSD256 DSD512* and DSD1024*.

* **DSD512** and **DSD1024** only with a Windows PC.

 If you wish the **SDV 3100 HV** to convert audio files from a Windows PC connected to it, you must first install driver software on the computer (see the chapter entitled '**USB DAC operation in detail**'). If you are using a computer running Mac OS X 10.6 or higher no drivers are necessary.

 Before switching to another input, you should stop playback in the player software.
If you switch to another USB input, the connection will be lost.

D/A Converter Operation

Selecting a D/A Converter Source

Choose the digital input to which you have already connected the source device which is to be played.

As soon as the source device delivers digital music data, the **SDV 3100 HV** automatically adjusts itself to the format and sampling rate of the signal, and you will hear the music.

Screen Display

 During D/A converter operations the **SDV 3100 HV** integral screen displays the characteristics of the digital input signal.

USB DAC operation in detail

System-requirements

- Intel Core i5 or higher or a comparable AMD Processor.
- 4 GB RAM
- USB 2.0 Interface
- Microsoft Windows 10, 8.1, 8 or 7
- Linux with 4.4 Kernel or higher
- or MAC OS X 10.13.6 or higher version

Installing drivers

The **SDV 3100 HV** can be operated with the listed MAC or Linux operating systems without requiring the installation of a driver. With MAC operating systems, DSD streams up to DSD256 and PCM streams up to 768 kHz can be played back.

If the device is to be operated in conjunction with one of the stated Windows operating systems, a dedicated driver must first be installed. With the driver installed, it is possible to play DSD streams up to DSD1024 and PCM streams up to 768 kHz.

 The drivers required are available for downloading from our website at <http://www.ta-hifi.com/support>

Settings

A number of system settings have to be altered if you wish to operate **SDV 3100 HV** with your computer. These changes must be made regardless of the operating system. The installation instructions provide detailed information on how and where the settings are to be changed.

Notes on software

 By default, the operating systems listed above do not support 'native' music playback. This means that the PC always converts the data stream to a fixed sample rate, regardless of the sample rate of the file to be played. Separate software is available - e.g. J. River Media Center or Foobar - which prevents the operating system converting the sample rate. The installation instructions included in the driver package contain further information on audio playback via USB.

Notes on operation

 To prevent fail functions and system crashes of your computer and the playback program, please note the following:

- For Windows OS: Install the driver before you use the **SDV 3100 HV** for the first time.
- Use only drivers, streaming methods (e.g. WASAPI, Directsound) and playback software which are compatible to your operating system and between each other.
- Never connect or disconnect the USB connection while the system is running.

Notes on setting up

 Do not set up the **SDV 3100 HV** on or immediately adjacent to the computer to which it is connected, otherwise the device could be affected by interference radiated by the computer.

Network Audio Adapter (NAA)

General information

Extremely high-resolution music is normally delivered to the **SDV 3100 HV** by the direct route via a USB connection between the audio workstation (Audio PC) and the **SDV 3100 HV**. However, since USB connections are limited to a maximum length of 3m the Audio PC must be set up in the immediate vicinity of the **SDV 3100 HV**.

In installations where the distance between PC and **SDV 3100 HV** is greater than this, what is known as a Network Audio Adapter is required, and the **SDV 3100 HV** incorporates this facility. This technology makes it possible to convey extremely high-resolution music files on the network: up to PCM768 and DSD1024. The Audio PC can then be installed in any location in the house.

Hardware and software requirements

In addition to the **SDV 3100 HV** you will need a high-performance Audio PC, a GigaBit network router, a LAN connection between the Audio PC and the **SDV 3100 HV** and “**HQPlayer**” software from the **Signalyst** company. A copy of “**roon-Server**” software from the **roonlabs** company can also be installed on the Audio PC to help you manage your music archive; it also provides a convenient means of controlling the entire system.



More information on HQPlayer and roon software can be found on the Internet at:

<https://www.signalyst.com/consumer.html>

and

<https://www./roonlabs.com/>

Network, connections

Since the transmission of ultra-high resolution music data using what is known as isochronous transfer mode requires data transfer at rates of up to 300 MBit per second with total immunity to interruption, all network components involved in the signal transfer must guarantee completely interference-free data transfer.

It therefore follows that it is not possible to use WLAN, or a 10 or 100 MBit LAN network, for this purpose. It is also necessary to isolate the audio network from the rest of the home network, so that other network traffic cannot interrupt or interfere with the audio data transmission. For details on connections please see the **Wiring diagram** in **Appendix A**.

Playback

- Select the **NAA** input (Network Audio) on the **SDV 3100 HV**. (it may be necessary to activate the input beforehand in the System Configuration menu. Please refer to the section entitled “Basic settings of the **SDV 3100 HV**”).
- Start HQ Player on the Audio PC.
- In HQPlayer select “**NetworkAudioAdapter**” as Backend under *File/Settings*.
- In HQPlayer select “**TA-NetworkAudio:DAC SDV 3100 HV: USB Audio**” as Device under *File/Settings*.
- In HQPlayer select “**None**” as SDM Pack under *File/Settings* (this enables native DSD transmission).
- Complete the remaining settings in accordance with the characteristics and capabilities of your Audio PC, then confirm with “**OK**” and leave the Settings menu.

If you now select a track in the HQPlayer control window, it should be audible via the **SDV 3100 HV**.



Switching to a different input on the SDV 3100 HV

Before switching to a different input you should stop playback in HQPlayer.

Switching to another USB input interrupts the connection to HQPlayer; playback in HQPlayer then stops, and the **SDV 3100 HV** disappears from the list of devices which can be selected in the Settings menu.

If you subsequently switch back to the “**NAA (Network Audio)**” input on the **SDV 3100 HV**, then the **SDV 3100 HV** automatically re-appears in HQPlayer, and you can resume playback.

Switching to a source other than USB maintains the connection between the **SDV 3100 HV** and HQPlayer. If music is playing in HQPlayer, it does not stop automatically; playback continues to run unless you stop or pause playback in HQPlayer.

Installation

Using the system for the first time

Safety notes

This section describes all those matters which are of fundamental importance when setting up and first using the equipment. This information is not relevant in daily use, but you should nevertheless read and note it before using the equipment for the first time.

Back panel connections

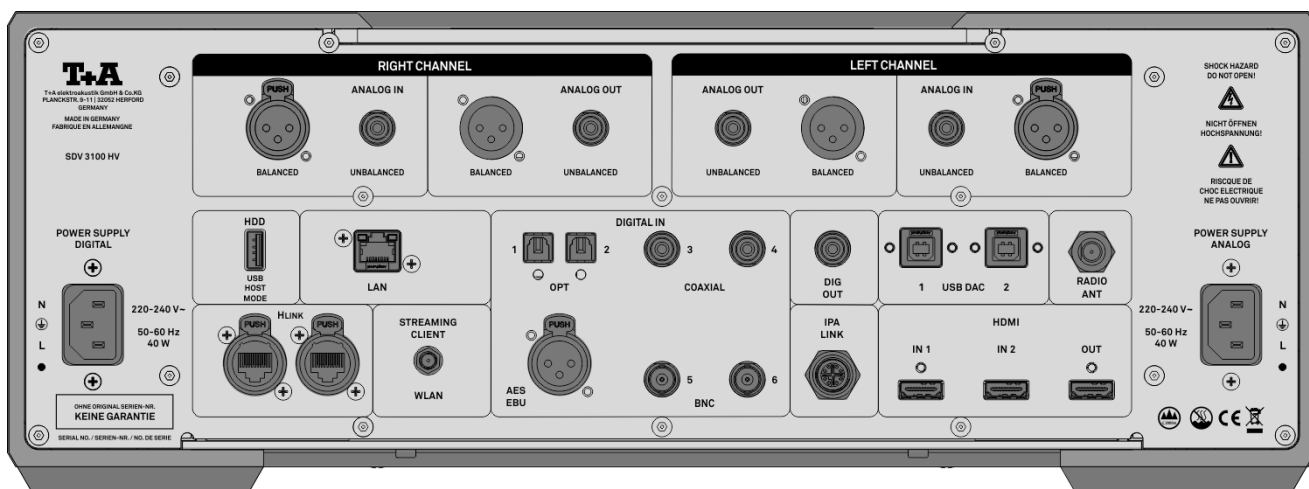

ANALOG OUT | BALANCED

The symmetrical XLR output delivers analogue stereo signals with a fixed level. It can be connected to the CD-input (line input) of any stereo pre-amplifier, integrated amplifier or receiver.

UN-BALANCED

The unbalanced RCA output of the **SDV 3100 HV** delivers analogue stereo signals with a fixed level. It can be connected to the CD-input (line input) of any stereo pre-amplifier, integrated amplifier or receiver.

i If both types of connection are present on the connected amplifier, we recommend the symmetrical option to obtain the best possible sound quality.

ANALOG IN | BALANCED

Universal line input for connecting any stereo audio device with balanced XLR output.

UN-BALANCED

Universal line input for connecting any stereo audio device with unbalanced RCA (Cinch) output.

USB HDD (Host mode)

Socket for a USB memory stick or external hard discs
The storage medium can be formatted with the FAT16, FAT32, NTFS, ext2, ext3 or ext4 file system.

i The USB storage medium can be powered directly via the USB port provided that its current drain is in accordance with the USB norm. Normalised 2.5" USB hard discs can be connected directly, i.e. without a separate mains PSU.

HLINK

Control output for **H**LINK – systems:
Both sockets are equivalent.



LAN

Socket for connection to a wired LAN (Ethernet) home network.

i The setting whether the device should be connected via WLAN or wired LAN must be set in the network configuration menu. See chapter "**Network configuration**".

WLAN

Input socket for WLAN antenna

-  The setting whether the device should be connected via WLAN or wired LAN must be set in the network configuration menu. See chapter "**Network configuration**".
-  The aerial should be set up free-standing using the magnetic base supplied in the set; this ensures maximum possible range.

DIGITAL IN (IN 1 ... IN 7)

Inputs for digital source devices with optical, co-axial (RCA / BNC) or AES-EBU digital outputs.

-  At its digital inputs the **SDV 3100 HV** accepts digital stereo signals (S/P-DIF signals) with sampling rates from 32kHz up to 192 kHz.

DIGITAL OUT

The signals of the selected source are available at this socket. They can be forwarded to another device such as a surround decoder or other DACs, e.g. for multi-room operation.

-  It is not always possible to produce a digital version for all media, as in some cases the original contains copy protection measures which prevent this.

IPA LINK

Special digital interface to connect the **PDT 3100 HV**. This connector is used to transmit digital signals in PCM and DSD format natively in the best possible quality.

-  This connector is intended exclusively for use with the **PDT 3100 HV**.

USB DAC

(Device mode)

Sockets for connecting a PC or MAC computer.

At this input the **SDV 3100 HV** accepts digital **PCM** stereo signals with sampling rates in the range **44.1** to **768 kSps**, and digital **DSD** stereo signals from **DSD64** to **DSD1024***.

* **DSD512** and **DSD1024** only with a Windows PC.

-  If you wish the **SDV 3100 HV** to convert audio files from a Windows PC connected to it, you must first install the appropriate drivers on the computer. No drivers are required if you are using a Linux or MAC computer (see the chapter '**USB DAC operation in detail**').

HDMI

HDMI inputs (**IN 1** and **IN 2**) for connecting a Blu-ray player or similar. At the "**OUT**" socket, the picture signals of the two input sockets "**IN 1**" and "**IN 2**" are available for passing on to a television.

RADIO ANT

The **SDV 3100 HV** features a 75 Ω aerial input **FM ANT**, which is suitable both for a normal domestic aerial and a cable connection. For first-class reception quality a high-performance, professionally installed aerial system is indispensable.

POWER SUPPLY



To avoid any coupling of unwanted noise signals from the digital power supply to the analogue power supply of the MP 3100 HV, the digital and analogue power supplies are located in separate shielded compartments on the left and right sides of the device. For best possible separation the power supplies have their own separate power supply sockets.

Always connect both mains sockets to the mains supply when operating the SDV 3100 HV.

Digital power supply

The mains lead for the digital power supply is plugged into this socket.

Analogue power supply

The mains lead for the analogue power supply is plugged into this socket.

For correct connections refer to the sections '**Installation and wiring**' and '**Safety notes**'.

Installation and wiring



Carefully unpack the unit and store the original packing material carefully. The carton and packing are specially designed for this unit and will be needed again if you wish to move the equipment at any time.

If you have to transport the device, it must always be carried or sent in its original packaging in order to prevent damage and defects.

The device is extremely heavy - caution is required when unpacking and transporting it. Always lift and transport the device with two persons.

Legal requirements pertaining to the lifting of heavy loads prohibit the transport of the device by women.

Ensure that you have a firm, secure hold on the device. Do not let it fall. Wear safety footwear when moving the device. Take care not to stumble. Ensure an unobstructed area of movement by removing obstacles and possible hindrances from the route.

Take care when lowering the device! To avoid your fingers being crushed, ensure that they are not trapped between the device and the support surface.

If the unit gets very cold (e.g. when being transported), condensation may form inside it. Please do not switch it on until it has had plenty of time to warm up to room temperature, so that any condensation evaporates completely.

If the device has been in storage, or has not been used for a protracted period (> two years), it is essential to have it checked by a specialist technician before re-use.

Before placing the unit on sensitive lacquer or wood surfaces please check the compatibility of the surface and the unit's feet on a non-visible point and if necessary use an underlay. We recommend a surface of stone, glass, metal or the like.

The unit should be placed on a rigid, level base (See also chapter "**Safety notes**"). When placing the unit on resonance absorbers or anti-resonant components make sure that the stability of the unit is not reduced.

The unit should be set up in a well ventilated dry site, out of direct sunlight and away from radiators.

The unit must not be located close to heat-producing objects or devices, or anything which is heat-sensitive or highly flammable.

Mains and loudspeaker cables, and also remote control leads must be kept as far away as possible from signal leads and antenna cables. Never run them over or under the unit.

Notes on connections:

A complete connection diagram is shown in '**Appendix A**'.

- Be sure to push all plugs firmly into their sockets. Loose connections can cause hum and other unwanted noises.
- When you connect the input sockets of the **SDV 3100 HV** to the output sockets on the source devices always connect like to like, i.e. '**R**' to '**R**' and '**L**' to '**L**'. If you fail to heed this then the stereo channels will be reversed.
- The device is intended to be connected to mains outlet with protective earth connector. Please connect it only with the mains cables supplied to properly installed mains outlets with protective earth connector.
- To achieve maximum possible interference rejection the mains plug should be connected to the mains socket in such a way that phase is connected to the mains socket contact marked with a dot (●). The phase of the mains socket can be determined using a special meter. If you are not sure about this, please ask your specialist dealer.

We recommend the use of the **T+A 'POWER THREE'** ready-to-use mains lead in conjunction with the '**POWER BAR**' mains distribution panel, which is fitted with a phase indicator as standard.

When you have completed the wiring of the system please set the volume control to a very low level before switching the system on.

The screen on the **SDV 3100 HV** should now light up, and the unit should respond to the controls.

If you encounter problems when setting up and using the amplifier for the first time please remember that the cause is often simple, and equally simple to eliminate. Please refer to the section of these instructions entitled '**Trouble shooting**'.

Loudspeaker and signal cables

Loudspeaker cables and signal cables (inter-connects) have a significant influence on the overall reproduction quality of your sound system, and their importance should not be under-estimated. For this reason recommends the use of high-quality cables and connectors.

Our accessory range includes a series of excellent cables and connectors whose properties are carefully matched to our speakers and electronic units, and which harmonise outstandingly well with them.

For difficult and cramped situations the **T+A** range also includes special-length cables and special-purpose connectors (e.g. right-angled versions) which can be used to solve almost any problem concerning connections and system location.

Mains cables and mains filters

The mains power supply provides the energy which your sound system equipment needs, but it also tends to carry interference from remote devices such as radio and computer systems.

Our accessory range includes the specially shielded '**POWER THREE**' mains cable and the '**POWER BAR**' mains filter distribution board which prevent electro-magnetic interference from entering your Hi-Fi system. The reproduction quality of our systems can often be further improved by using these items.

If you have any questions regarding cabling please refer to your specialist dealer who will gladly give you comprehensive expert advice without obligation. We would also be happy to send you our comprehensive information pack on this subject.

Care of the unit

Disconnect the mains plug at the wall socket before cleaning the case.

The surfaces of the case should be wiped clean with a soft, dry cloth only.

Never use solvent-based or abrasive cleaners!

Before switching the unit on again, check that there are no short-circuits at the connections, and that all cables are plugged in correctly.

Storing the unit

If the device has to be stored, place it in its original packaging and store it in a dry, frost-free location. Storage temperature range 0...40 °C

Changing the batteries:

Remove the screw marked in the figure below, to open the battery compartment, then withdraw the cover. Insert two new cells of the **LR 03 (MICRO)** type, taking care to maintain correct polarity as shown. Please note that you must **always replace all the cells**.

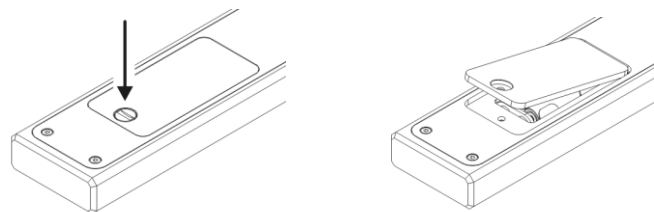

Caution!

Batteries should not be exposed to excessive heat like sunshine, fire or the like.



Exhausted batteries must never be thrown into the household waste! They should be returned to the battery vendor (specialist dealer) or your local toxic waste collection point, so that they can be recycled or disposed in a proper way. Most local authorities provide collection centres for such waste, and some provide pick-up vehicles for old batteries.

Disposing of exhausted batteries

Safety notes

	<p>For your own safety please consider it essential to read these operating instructions right through, and observe in particular the notes regarding setting up, operation and safety.</p>
Installation	<p>Please consider the weight of the device. Never place the device on an unstable surface; the machine could fall off, causing serious or even fatal injury. Many injuries, especially to children, can be avoided if the following simple safety precautions are observed:</p> <ul style="list-style-type: none">• Use only such items of furniture which can safely bear the weight of the device.• Ensure that the device does not project beyond the edges of the supporting furniture.• Do not place the device on tall furniture (e.g. bookshelves) without securely anchoring both items, i.e. furniture and device.• Explain to children the hazards involved in climbing on furniture to reach the device or its controls. <p>When installing the unit on a shelf or in a cupboard it is essential to provide an adequate flow of cooling air, to ensure that the heat produced by the unit is dissipated effectively. Any heat build-up will shorten the life of the unit and could be a source of danger. Be sure to leave free space of 10 cm around the unit for ventilation.</p> <p>The ventilation openings must not be covered or closed.</p> <p>If the system components are to be stacked then the device must be the top unit. Do not place any object on the top cover.</p> <p>The unit must be set up in such a way that none of the connections can be touched directly (especially by children). Be sure to observe the notes and information in the section 'Installation and Wiring'.</p>
Connection	<p>The terminals marked with the -symbol can carry high voltages. Always avoid touching terminals and sockets and the conductors of cables connected to them. Unless ready-made cables are used, all cables connected to these terminals and sockets must always be deployed by a trained person.</p>
Power supply	<p>The device is intended to be connected to mains outlets with protective earth connector. Please connect it only with the mains cables supplied to properly installed mains outlets with protective earth connector.</p> <p>The power supply required for this unit is printed on the mains supply sockets. The unit must never be connected to a power supply which does not meet these specifications. If the unit is not to be used for a long period disconnect it from the mains supply at the wall socket.</p>
Mains leads / Mains plug	<p>Mains leads must be deployed in such a way that there is no danger of damage to them (e.g. through persons treading on them or from furniture). Take particular care with plugs, distribution panels and connections at the device.</p> <p>To disconnect the device completely from mains power supply, the mains plugs must be withdrawn from the wall socket. Please make sure that the mains plugs is easily accessible.</p>
Enclosure openings	<p>Liquid or particles must never be allowed to get inside the unit through the ventilation slots. Mains voltage is present inside the unit, and any electric shock could cause serious injury or death. Never exert undue force on mains connectors.</p> <p>Protect the unit from drips and splashes of water; never place flower vases or fluid containers on the unit.</p> <p>Do not place naked flame sources, such as candle lights on the device.</p>
Supervision of device operation	<p>Like any other electrical appliance this device should never be used without proper supervision. Take care to keep the unit out of the reach of small children.</p>

Service, Damage

The case should only be opened by a qualified specialist technician. Repairs and fuse replacements should be entrusted to an authorised specialist workshop. With the exception of the connections and measures described in these instructions, no work of any kind may be carried out on the device by unqualified persons.

If the unit is damaged, or if you suspect that it is not functioning correctly, immediately disconnect the mains plug at the wall socket, and ask an authorised specialist workshop to check it.

Over voltage

The unit may be damaged by excess voltage in the power supply, the mains circuit or in aerial systems, as may occur during thunderstorms (lightning strikes) or due to static discharges.

Special power supply units and excess voltage protectors such as the **T+A 'Power Bar'** mains distribution panel offer some degree of protection from damage to equipment due to the hazards described above.

However, if you require absolute security from damage due to excess voltage, the only solution is to disconnect the unit from the mains power supply and any aerial systems.

To avoid the risk of damage by overvoltages we recommend to disconnect all cables from this device and your HiFi system during thunderstorms.

All mains power supply and aerial systems to which the unit is connected must meet all applicable safety regulations and must be installed by an approved electrical installer.

Approved usage



The device is designed to operate in a temperate climate and altitudes up to 2000 m above sea level. The range of permissible operating temperatures is +10 ... +35°C. This device is designed exclusively for reproducing sound and/or pictures in the domestic environment. It is to be used in a dry indoor room which meets all the recommendations stated in these instructions.

Where the equipment is to be used for other purposes, especially in the medical field or any field in which safety is an issue, it is essential to establish the unit's suitability for this purpose with the manufacturer, and to obtain prior written approval for this usage.

Approval and conformity with EC directives

In its original condition the unit meets all currently valid European regulations. It is approved for use as stipulated within the EC.

By attaching the CE symbol to the unit **T+A** declares its conformity the EC directives and the national laws based on those directives. The declaration of conformity can be downloaded from www.ta-hifi.com/DoC.

The original, unaltered factory serial number must be present on the outside of the unit and must be clearly legible! The serial number is a constituent part of our conformity declaration and therefore of the approval for operation of the device. The serial numbers on the unit and in the original documentation supplied with it (in particular the inspection and guarantee certificates), must not be removed or modified, and must correspond.

Infringing any of these conditions invalidates conformity and approval, and the unit may not be operated within the EC. Improper use of the equipment makes the user liable to penalty under current EC and national laws.

Any modifications or repairs to the unit, or any other intervention by a workshop or other third party not authorised by , invalidates the approval and operational permit for the equipment.

Only genuine accessories may be connected to the unit, or such auxiliary devices which are themselves approved and fulfil all currently valid legal requirements.

When used in conjunction with auxiliary devices or as part of a system this unit may only be used for the purposes stated in the section '**Approved usage**'.

Disposing of this product



The only permissible method of disposing of this product is to take it to your local collection centre for electrical waste.

Network Configuration

General Information

The **SDV 3100 HV** can be operated in wired LAN networks (*Ethernet LAN* or *Powerline LAN*) or in wireless networks (*WLAN*).

If you wish to use your **SDV 3100 HV** in your home network, you must first enter the necessary network settings on the **SDV 3100 HV**. This includes entering the network parameters such as the IP address etc. both for wired and wireless operation. If you wish to use a wireless connection, a number of additional settings for the WLAN network also have to be entered.

Please refer to the Chapter '**Glossary / Additional Information**' and '**Network Terms**' for additional explanations of terminology relating to network technology.



In the following sections we assume that a working home network (cable network or WLAN network) **with router and (DSL) Internet access is present.**

If you are unclear about some aspect of installing, setting up and configuring your network, please address your queries to your network administrator or a network specialist.

Compatible hardware and UPnP servers



The marketplace offers a vast number of routers, NAS devices and USB hard discs made by a very wide range of manufacturers. equipment is generally compatible with other makes of machine which bear the UPnP label.



Network settings menu

All network settings are entered in the Network Configuration menu. This menu will vary slightly in appearance depending on the type of your network, i.e. whether you have a wired (LAN) or wireless (WLAN) network.



In the network configuration menu under the item '**Interface**', first the desired connection type must be set.

Opening the network settings menu

Open the System Configuration menu by pressing the  button on the remote control handset or the  button on the front panel of the **SDV 3100 HV**.



Use the  /  buttons to select the "**Network**" menu item, then confirm by pressing the  button.

Operating the menu, changing and storing IP addresses

Use the  /  buttons in the menu to select the network parameter to be changed, and activate the entry with the  button.

You can now change the setting using the following buttons, depending on the type of setting:



 /  button for simple selection (ON / OFF)



Numeric buttons  to  for entering IP addresses

Alpha-numeric input for entering text

When the setting process is complete, or when you have entered the complete address, press the  button to confirm your action.

Alpha-numeric entry

At certain points, e.g. for entering server names or passwords, it is necessary to input series of characters (strings). At such points you can enter letters, numbers and special characters by repeatedly pressing the numeric buttons on the **F3100** remote control handset, as when writing SMS news. The assignment of letters to the buttons is printed below the buttons. Special characters can be accessed using the  and  buttons:

 0 + - * / ^ = { } () [] < >
 . , ? ! : ; ' \ " ' _ @ \$ % & # ~





Use the  button for toggling between numbers, capitals and lower-case letters. The bottom line of the screen shows which input mode is currently selected.

 At certain points (e.g. DNS server name) it is possible to enter both an alpha-numeric string and an IP address. At these points an IP address should be entered like a string (with separating dots as special characters). In this case an automatic check for valid address ranges (0 ... 255) is not carried out.

Closing the menu

Once you have correctly set all the parameters, select the menu item '**Store and exit?**', then press the  button. This action causes the **SDV 3100 HV** to accept the settings, and you should see the available network media sources (Internet radio, UPnP-AV server, etc.) displayed in the main menu.

Interrupting the menu without storing the settings

At any time you can leave the network configuration menu without making any changes to the network settings: this is done by pressing the  button, which takes you to the menu item '**Store and exit?**'. If you wish to quit at this point without saving, use the  /  buttons to select the '**Discard and exit?**' menu item, then confirm with the  button.

The Configuration for a Wired Ethernet LAN or Power-Line LAN connection

Setting the Parameters for a Wired Network

- Connect the **SDV 3100 HV** to an operational network or Power-Line modem using the LAN socket on the back panel.
- Switch the **SDV 3100 HV** on, Open the System Configuration menu by pressing the **(SRC/SYS)** button on the remote control handset or the **(⚙)** button on the front panel of the **SDV 3100 HV**.
- Use the **(◀)** / **(▶)** buttons to select the menu point **"Network"**, then confirm your choice with the **(OK)** button.
- If necessary select under the menu item **"Interface"** the option **"LAN"**
- You should now see the menu reproduced below, displaying the network parameters.
- You can now select the individual menu points and adjust them to match your network conditions. The illustration below shows the possible button inputs after each menu item.

Network settings menu		Possible entries
MAC	00:0e:9b:cc:a4:35	none
Connection state	LAN	none
Interface	LAN	(◀) / (▶)
DHCP	Off	(◀) / (▶)
IP	192.168.0.10	(0 ... 9)
Subnet mask	255.255.255.0	(0 ... 9)
Gateway	192.168.0.1	(0 ... 9)
DNS	192.168.0.1	(0 ... 9, A ... Z)
Store and exit?	apply	(OK)
Discard and exit?	apply	(OK)



- (◀)** / **(▶)**: Switching ON / OFF
- (0...9)**: Numeric input, separating dots are automatically generated; input limited to valid addresses
- (0...9, A...Z)**: Alpha-numeric input and special characters. IP - separating dots must be entered as special characters.









(i) The parameters illustrated above are only typical values. Addresses and settings may require different values for your network.

Menu Point	Description
MAC	The MAC address is a hardware address which uniquely identifies your machine. The address displayed is determined by the manufacturer, and cannot be altered.
Connection state	Shows the connection state: WLAN, LAN or not connected.
Interface	Here you can select whether the device should be connected via WLAN or LAN.
DHCP	<p>ON If your network includes a DHCP server, please select the ON setting at this point. In this mode an IP address is automatically assigned to the SDV 3100 HV by the router. The screen shows only the MAC address and the message DHCP state ON. In this case the address input fields shown in the illustration do not appear in the menu.</p> <p>OFF If your network does not include a DHCP server, please select the OFF setting. In this mode you must configure the following network settings manually. Please ask your network administrator for the addresses to be entered for your network.</p>
IP	IP address of the SDV 3100 HV
Subnet mask	Network mask
Gateway	IP address of the router
DNS	Name / IP of the name server (optional)
Store and exit?	Stores the network parameters, and restarts the SDV 3100 HV with the new settings.
Discard and exit?	Closes the menu: data already entered is discarded.

The Configuration for a WLAN connection





Setting the parameters for a wireless network

- Check that there is no cable connected to the LAN socket of the **SDV 3100 HV**.
- Connect one of the WLAN aerials from the accessories enclosed to the WLAN socket.
- Switch the **SDV 3100 HV** on, open the System Configuration menu by pressing the button on the remote control handset or the button on the front panel of the **SDV 3100 HV**.
- Use the  /  buttons on the remote control handset to select the menu point "**Network**", then confirm your choice with the  button.
- Select under the menu item "**Interface**" the option "**WLAN**".
- The following menu items are displayed for WLAN configuration:

Network settings menu		Possible entries
MAC	00:0e:9b:cc:a4:35	none
Connection state	not connected	none
Interface	WLAN	 / 
→ WPS Autoconnect	apply	
Scan for WLAN	apply	
DHCP	Off	 / 
IP	192.168.0.10	(0 ... 9)
Subnet mask	255.255.255.0	(0 ... 9)
Gateway	192.168.0.1	(0 ... 9)
DNS	192.168.0.1	(0 ... 9, A ... Z)
Store and exit?	apply	
Discard and exit?	apply	



Selecting and connecting a WLAN by hand

Searching for and Selecting the Network

- First select the menu point "**Scan for WLAN**", and activate it by pressing the  button.
- A list of the WLANs found is displayed on the screen.
- Use the  /  buttons to select the WLAN to which you wish the **SDV 3100 HV** to be connected, and confirm your choice with the  button.

Entering the Password (for encoded networks)

If the network is encoded, the window shown below will appear once the WLAN is selected.

- At this point please enter the network passphrase and confirm your input by pressing .
- Select the "**Store and exit?**" point, and confirm your choice with .

Network settings menu		Possible entries
SSID:	Name of the WLAN	none
Login:	Man. (WPA/WPA2)	none
→ Passphrase:	xxxxxxx	(0 ... 9, A ... Z)
Store and exit?	apply	

Storing Network Settings and Restarting

Finally select the "**Store and exit?**" menu point and press the  button to accept the settings.







If a WEP code is used, the password must be entered as a hexadecimal code (0 - 9, A - F).

Connecting to WLAN via the WPS-function

WPS-function





The **SDV 3100 HV** supports WPS for WLAN setup. WPS (Wi-Fi Protected Setup) an easy process for establishing a secure WLAN connection. WPS can be used to connect the **SDV 3100 HV** with your router in a quick and convenient way. For that usage most modern routers have implemented the WPS function.

Connecting WLAN automatically via the WPS function

- First activate the WPS-function of the Router or Repeater to which you wish the **SDV 3100 HV** to be connected. For details please refer the manual of the device in question.
- Start the WPS-Autoconnect function of the **SDV 3100 HV** within 2 minutes.
- Use the  /  buttons to select the menu point “**WPS-Autoconnect**”, then confirm your choice with the  button.
- After the connection is established, the line “Status” shows the connected WLAN network.
- Finally select the “**Store and exit?**” menu point and press the  button to accept the settings.

Selecting the WLAN manually and connecting via WPS





If the WPS function connects the **SDV 3100 HV** to the wrong WLAN, the preferred WLAN can be also selected manually and only the authentication can be done by the WPS function. The procedure is described in the following:

- First activate the WPS-function of the Router or Repeater to which you wish the **SDV 3100 HV** to be connected. For details please refer the manual of the device in question.
- First select the menu point “**Scan for WLANs**”, and activate it by pressing the  button.
- A list of the WLANs found is displayed on the screen.
- Use the  /  buttons to select the WLAN to which you wish the **SDV 3100 HV** to be connected, and confirm your choice with the  button

The window shown below will appear once the WLAN is selected:

Network settings menu	
SSID:	Name of the WLAN
Login:	Auto (WPS)
→ Passphrase:	xxxxxxx
Store and exit?	apply

none
none
(0 ... 9, A ... Z)

- Select the “**Login**” menu point and press the  button to activate it. Now select the setting „**Auto (WPS)**“ and confirm it with the  button.
- Now select the “**Store and exit?**” menu point and press the  button.
- After the connection is established, the line “**Status**” shows the connected WLAN network.
- Finally select the “**Store and exit?**” menu point and press the  button to accept the settings.

WLAN setup via access point

General information

The **SDV 3100 HV** supports setting up the WLAN connection via an access point and the **T+A Music Navigator App**. This means that the **SDV 3100 HV** provides its own WLAN for the duration of the configuration of the WLAN settings. As soon as the configuration is complete, this WLAN is deactivated again. The **SDV 3100 HV** restarts and connects to the WLAN configured via the app.

Music Navigator App

For Apple (iOS)



For Android



Setup WLAN

- Turn on the **SDV 3100 HV** and open the system configuration menu by a long press on the **(SRC/SYS)** button on the remote control or the **(⊕)** button on the front of the **SDV 3100 HV**.
- Use the **(▲)** / **(▼)** buttons to select the menu point **"Network"**, then confirm your choice with the **(OK)** button.
- Select under the menu item **"Interface"** the option **"WLAN"**
- Use the **(▲)** / **(▼)** buttons to select the menu point **"Access Point"**, then confirm your choice with the **(OK)** button.
- The **SDV 3100 HV** activates the WLAN access point..
- The following steps must be performed within approximately 5 minutes. After this time, the **SDV 3100 HV** will exit Access point mode automatically.
- Connect the smartphone or Tablet PC on which the **T+A**-App is installed to the WLAN access point. The network name (SSID) is **"T+A AP SDV3100HV"** and the passphrase is **"01234567"**.
- Start the **T+A** -App for operation.
- The app recognizes the access point and starts automatically with the setup wizard.
- To set up the WLAN, go through the individual steps of the app's setup wizard.
- Quit the app, then connect your phone or tablet to your previously set up wireless LAN.
- After restarting the app the **SDV 3100 HV** will be detected automatically.
- Once the **SDV 3100 HV** is detected, it can be selected for playback.

Notes on Energy Saving

General information

The **SDV 3100 HV** satisfies the requirements of the latest directives concerning energy-saving measures (EuP directive). The modern design of the mains power supply makes an important contribution to this.

The internal micro-processor constantly ensures that sub-assemblies which are not currently required are automatically switched off. The micro-processor itself operates in stand-by mode at a relatively low clock speed, and only responds to the remote control receiver.

In stand-by mode the current drain of the **SDV 3100 HV** is less than 0.5 Watt. If you intend not to use the device for a long period, it should be disconnected from the mains socket, i.e. the mains plug should be withdrawn from the wall socket.

Automatic power-down (Energy saver)

The device features an automatic power-down function. If the **SDV 3100 HV** detects no operation or no music signal for a period longer than ninety minutes, it automatically switches to stand-by mode. Two minutes before the device enters the standby mode, a pop-up window appears on the screen. If the device should stay in operation please press any button while this message is displayed.



In countries outside the EU, in which the EuP directive has no validity, the automatic power-down feature can be disabled if necessary (see chapter entitled '**Basic settings of the SDV 3100 HV**').

Firmware update

General information

Many features of the **SDV 3100 HV** are software based. Updates and new features will be made available from time to time. For updating the firmware of the **SDV 3100 HV** there is a convenient method which requires an existing Internet connection

If you are operating the **SDV 3100 HV** in conjunction with a **PDT 3100 HV**, the machine can also be updated via the **HLink** connection.

The wiring diagram for the machine is shown in '**Appendix A**'.

The following section describes the exact method of updating the firmware in detail.

Updating via the Internet

Updating the firmware via the SDV 3100 HV's Internet connection

- The basic requirement is a functioning network with router and access to a broadband Internet connection; the system must be operating.
- Switch the machine on.
- Call up the System menu by pressing the  button on the front panel.
- Rotate the **SELECT** knob on the front panel to select the “**Device info**” menu point, and confirm your selection by pressing the **SELECT** knob.
- If the **SDV 3100 HV** is connected to a **PDT 3100 HV** via the **HLink** connection, the Select Device menu appears at this point. In this case select the device to be updated by turning the **SELECT** knob, then press the **SELECT** knob to confirm your choice.

(If the **SDV 3100 HV** is not connected to a **PDT 3100 HV**, the Software Update menu of the **SDV 3100 HV** appears directly.)

- Select the “**Update**” menu point by rotating the **SELECT** knob, then press the **SELECT** knob to confirm your choice.
- The Select option “**WEB**” should now be active (highlighted).
- The firmware update can now be started by pressing the **SELECT** knob.
- The screen displays the current state of progress of the update.
- Once the update has been completed (duration around ten minutes) the device automatically switches itself off and restarts.
- When the machine has restarted, the update is complete.
- To ensure that the update was successful, access the “**Device Info**” menu point mentioned above, and check the new firmware status.



It is also possible to carry out the update process using the F3100 remote control handset, as an alternative to operating the machine directly. The method of operating the menu using the handset is described in the chapter entitled “**Basic settings of the SDV3100 HV**” (Using the remote control handset).

Technical description – D/A conversion

PCM

Oversampling

The audio data on for example CDs is stored at a sampling rate of 44.1 kHz - i. e. for each second of music 44.100 sampled values are available for each channel. In the **SDV 3100 HV** the audio data read from the CD is „multiplied“ to a higher sampling rate before it is converted back into analogue music signals. This process delivers a very much better, more finely graduated signal to the converter, which can then be converted with correspondingly higher precision. The raised sampling rate is a calculating process for which there are many different mathematical methods. In almost all digital audio devices which exploit the advantages of increased digital sampling rate a process known as a FIR filter is employed for this purpose. At **T+A** we have been carrying out research for more than ten years, aimed at improving the oversampling process, because the standard FIR method has one drawback to set against its indisputable advantages: it adds small pre- and post-echoes to the music signals. At **T+A** we have developed mathematical processes (known as Bezier polynomial interpolators) which do not share this disadvantage. For this reason they should sound better and more natural than the usual standard process. Since the calculating procedure employed by us is considerably more complex than the standard method, the **SDV 3100 HV** features a digital high precision floating point signal processor (DSP) which carries out the over-sampling process using special algorithms developed by **T+A**.

The freely programmable DSP which we use is capable of carrying out the oversampling process using any method of calculation. For this reason we have implemented a slightly modified Bezier process (filters3) in the **SDV 3100 HV** in addition to the pure Bezier process (filter 4), together with two variants of the standard process (filter 1 and filter 2). For more information on the different processes please refer to the next section. You can switch between the various algorithms, then decide for yourself which of the filters gives the results you prefer.

FIR long (Standard FIR Filter)

The long FIR filter is the standard oversampling process in digital technology, offering extremely linear frequency response, very high damping, linear phase characteristics and constant group delays. The disadvantage is the pre- and post-echoes which are added to the signal. These „time range errors“ tend to affect the music signal's dynamics, precision and naturalness, and reduce spatial orientation.

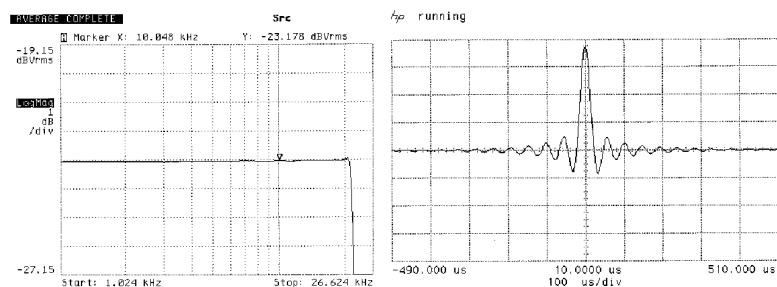

Frequency response and transient characteristics of the long FIR filter

FIR short (Impulse optimised filter)

Shortening the filter (lower coefficient) reduces the time range errors, albeit combined with a slight loss of linearity in the frequency range and damping performance.

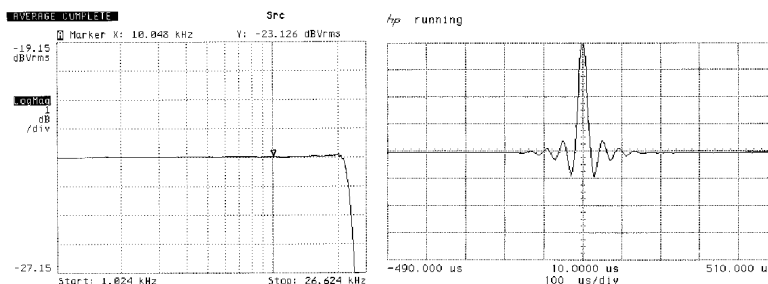

Frequency response and transient characteristics of the short FIR filter

Bezier / IIR (Bezier-interpolator plus IIR-filter)

In this process an ideal Bezier interpolator is combined with what is known as an IIR filter. This eliminates the problematic pre-echo of the FIR method. This process produces highly „analogue“ system characteristics, with a sound quality and measured performance similar to those of good analogue record players.

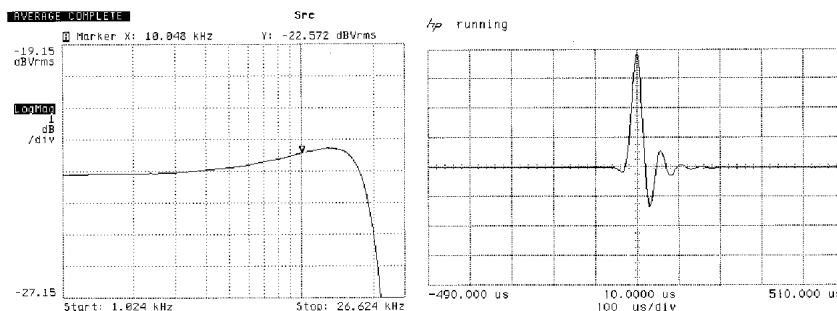

Frequency response and transient characteristics of the Bezier interpolator plus IIR filter

Bezier (pure Bezier interpolator)

This process delivers a perfect reconstruction of the original music signal. It exhibits no pre- or post-echoes of any kind, and does not add coloration or timing errors to the original signal. In sonic terms this method offers an impressive blend of naturalness, good dynamics and accuracy.

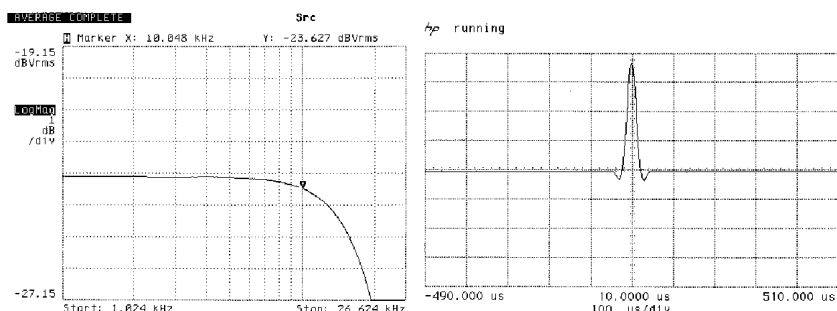

Frequency response and transient characteristics of the Bezier interpolator

DSD

General information

The **SDV 3100 HV** has two different converter modes for playback of DSD streams. The optimal setting of the DSD mode varies with the DSD rate and the music being played. Both modes have their advantages. The setting should therefore be made according to your personal listening preferences.

DSD 1

The **DSD 1** mode uses 16 output stages connected in series to convert the DSD bit stream. These are summed up and then output after weighting (K1 to K16). The output stages work with a maximum frequency of 49.2 MHz.

Due to the long filter the noise is very low and the interference rejection is very good.

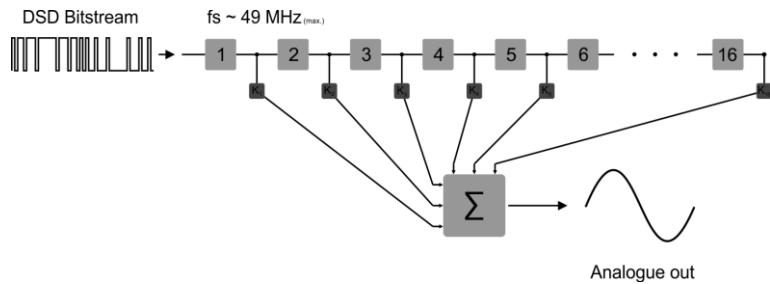

DSD 2

The **DSD 2** mode uses eight output stages connected in series twice to convert the DSD bitstream, which in turn are connected in parallel. The two chains only have to process half of the stream information. This means that the output stages only work with half the frequency (24.6 MHz).

Due to the lower clock frequency, the signal can be converted even more precisely. The DSD 2 mode has a lower distortion compared to the DSD 1 mode.

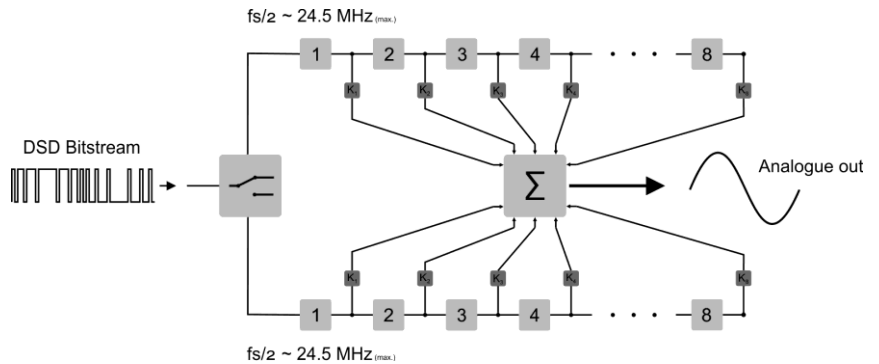

Frequency bandwidth of the analogue reconstruction filter

Normal operation up to 60 kHz and 'Wide'-Mode up to 120 kHz

The 'WIDE' setting produces the best sound quality, but only with high-quality amplifiers which are able to process signal frequencies up to 300 kHz without generating distortion.

If you are in any doubt about the ability of your amplifier to deal with very high signal frequencies up to 300 kHz, please check this with the manufacturer of your equipment.

Alternatively you can set the switch to the WIDE setting, and simply listen to the results. If you hear no interference, and if the sound image is better than that in the NORMAL setting, leave in the WIDE mode.

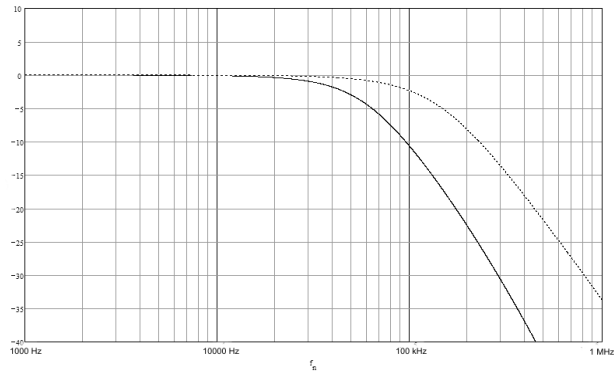

Frequency bandwidth of the two settings



The 'WIDE' setting can be used without restriction with all amplifiers

Network Terminology

General information

The Switch ensures that the individual components within a network are connected correctly. This is only possible if it can identify each device within the network unambiguously; this is the reason why every component is assigned a form of “house number” (IP address). The IP address consists of four number blocks each containing three digits separated by dots (e.g. 192.168.1.1).

Each of the individual number blocks may contain values between 1 and 254 (the values 0 and 255 are reserved for certain special functions, and should therefore not be used). However, if the network is to operate reliably, the network owner should only select addresses designed for home network use - i.e.: the first two number blocks should always be 192.168.xxx.xxx; the third block can be selected without restriction within the above limits (but should be the same for all devices on the network), and the fourth block must distinguish each device uniquely (e.g.: **SDV 3100 HV** 192.168.001.001, NAS: 192.186.001.002, PC: 192.168.001.003, ...).

If this local network is to include Internet music sources (Internet radio) as well as physical devices, then the **SDV 3100 HV** must have access to the Internet. This facility is provided by a device such as a router with connection to the DSL network. This router is also a constituent part of the network, and is assigned its own IP address. The **SDV 3100 HV** must also be informed of the address of the router (Gateway) to enable it to gain access to the outside world.

 Please ensure that the first three blocks of the Device IP, Gateway IP and DNS 1 share the same address space (e.g. 192.168.0.xxx). The fourth block assigns a unique address (house number) to the components in the local network. This number must not be present more than once in the local network.

The Device IP mask should always be assigned the address 255.255.255.0.

DNS

The Domain Name System (DNS) is one of the most important services on the Internet. Its primary task is to convert “Internet addresses”, such as www.taelektroakustik.de, into the associated IP address. In most home networks the router carries out the DNS function.

If you decide to configure your network manually (without DHCP), then simply enter the address of your router as the DNS address when configuring the network.

Ethernet-LAN

Wired network. Interference-free network technology, with the drawback of having to deploy a network cable.

Gateway

The computer or router in your network which is responsible for managing data traffic between your home network and the outside world (i.e. the Internet).

Client

Network device which obtains data from the network, decodes it and converts it into, for example, analogue music signals which can then be reproduced via an amplifier and loudspeakers. Streaming Clients also contain functions for displaying media content, and for navigating on the Internet or servers.

DHCP

DHCP is an abbreviation of **D**ynamic **H**ost **C**onfiguration **P**rotocol. The primary purpose of DHCP is to enable Clients to obtain your network configuration automatically from a server or router.

IP-Address

Network address. Each device in the network requires an IP address at which it can be accessed, and by which it is unambiguously identifiable. No individual network address may be present more than once. This is important if you are entering network addresses manually. If the addresses in your network are assigned by DHCP, you do not need to worry about IP addresses at all, as the DHCP server manages the addresses automatically without your intervention.

NAS (Network Attached Storage)	Network storage facility. This is generally a very large-capacity (> 200 GB) storage device to which other devices have access. If the NAS server includes an UPnP-AV server service, then the SDV 3100 HV has access to media files stored on the NAS, and can play them back.
Powerline-LAN	In a Power-Line LAN data is transferred via the existing mains power cabling. Devices known as "Power-Line modems" are required at the transmitting and receiving end. In most cases Power-Line offers relatively problem-free data transfer with adequate data rates for audio streaming. We recommend Power-Line modems with bit rates of 85 or 200 Mbit/s.
Proxy server	A Proxy or Proxy server is a computer in the network which is capable of carrying out data transfers faster and more efficiently, and can increase security through the use of access control mechanisms. Most home networks do not include a proxy server. In this case there is no need to enter a Proxy address when configuring the SDV 3100 HV network.
Router	Central network device which creates and manages the connections between the network devices. In most networks the router also assumes the function of Gateway to the outside world.
Server	Network device which provides data and services for other devices in the network. For example, an UPnP-AV server typically stores audio / video data, and makes it available to other devices (the Streaming Clients). Many UPnP-AV servers also offer functions such as cataloguing, and easy identification of media content using criteria such as artiste, album name, genre, etc.
UPnP-AV	<p>Network protocol that makes media files available on the home network.</p> <p>On PCs and NAS storage devices an UPnP-AV server software must be installed to enable the SDV 3100 HV to access media files stored on these devices.</p> <p>Examples for UPnP-AV server software compatible with the SDV 3100 HV:</p> <p>Windows:</p> <ul style="list-style-type: none"> • Twonky Media Server http://www.twonkyvision.de/ • Windows Media Player 11 http://www.microsoft.com/windows/windowsmedia/de/default.aspx <p>Linux:</p> <ul style="list-style-type: none"> • Mediatomb http://mediatomb.cc/ • GmediaServer http://www.gnu.org/software/gmediaserver/
WLAN (also W-LAN, Wireless LAN)	Radio network. The network is connected by means of radio waves operating in the 2.4 GHz frequency band. Radio networks are easy to install as no cables have to be deployed, but they are often problematic and unreliable - especially when the transmission distances are substantial. Power-Line networks, which can also be installed without separate cabling, are a better choice in many situations. In every case the deployment of a network cable is the most reliable and problem-free technology for data transfer.
Compatible hardware and UPnP servers	The marketplace offers a vast number of routers, NAS devices and USB hard discs made by a very wide range of manufacturers. equipment is generally compatible with other makes of machine which bear the UPnP label. A list of devices which has checked for compatibility can be found on the Internet at: http://www.taelektroakustik.de/hardware/comp_lan_hw.pdf .

Trouble shooting

Many problems have a simple cause and a correspondingly simple solution. The following section describes a few difficulties you may encounter, and the measures you need to take to cure them. If you find it impossible to solve a problem with the help of these notes please disconnect the unit from the mains and ask your authorised **T+A** specialist dealer for advice.

Machine does not switch on**Cause 1:**

Mains lead not plugged in correctly.

Remedy:

Check connection, push connector in firmly.

Cause 2:

Mains switch on the back panel not switched on.

Remedy:

Switch the mains switch on.

Device makes click noises**Cause :**

The clicking is caused by the gold contact relays. These are responsible for the volume control, switching and muting of the audio signal. Relays are the technically best solution for these applications. Therefore, clicking is a quality feature and not a shortcoming.

FM radio

Whistling or whispering noises from the speakers.**Cause:**

The antenna lead is routed too close to a mains, remote control or audio signal cable.

Remedy:

Move the leads so that they are spaced well apart. Use the domestic (loft or outside) antenna or a cable connection.

The RDS station name does not appear in the display.**Cause 1:**

The station is not broadcasting RDS information.

Cause 2:

Reception is poor, interference is severe, or the *field strength* (signal strength) is low.

Remedy:

Select only those stations which can be received with a strong signal: hiss-free and without interference.

The unit can be operated normally, but very few stations or none at all can be picked up.**Cause:**

The antenna system or antenna cable is faulty.

Remedy:

Check the antenna lead for good contact at the antenna socket (at the wall) and in the back of the tuner. As a test, try using the system with a trailing antenna. If you can now receive stations reasonably well, we recommend that you call out an expert antenna technician to check your antenna system.

Streaming Client

USB Storage device is not recognised

Cause 1:

The storage device (especially USB hard discs without separate power supply) draws more electrical current from the USB interface than is permitted by the USB standard.

Remedy:

Only use USB storage devices that conform to the USB standard or use storage devices with own power supplies.

**The streaming client cannot connect to a network.
On the display the indication 'Cannot connect to...' is displayed.**

Cause 1 (cable LAN):

Network cable not properly connected

Remedy:

Connect network cable, check connection to router

Cause 2 (wireless LAN):

WLAN reception quality bad (low field strength). Possibly too much attenuated by walls/ceilings on the transmission path.

Remedy:

Optimize location of receiver and transmitter antennas.

Alternative:

If transmission problems persist a so called 'Power Line' network might be good alternative to establish a good and stable network connection.

The best, safest and most secure network however will always be a cable LAN network.

Cause 3:

Network parameters not properly configured.

Remedy:

Configure the network parameters correctly (see chapter '**Network configuration**').

Cause 4:

The network cable was connected after switching on the device.

Remedy:

Switch the device at the front off and on again. The network parameters correctly (see chapter 'Network configuration').

Transmission interruptions occur when listening to internet radio stations.

Cause 1:

The capacity of the internet radio station's server is at its limit.

Remedy:

Choose a different station.

Cause 2:

Network problems occurred.

Remedy:

Check your network (see above).

Some internet radio stations cannot be received

Cause:

The internet radio station has been switched off, it transmits only at certain hours of the day or it has changed its internet address.

Remedy:

Try to get information from the website of the station regarding transmission hours and internet address (URL).

Try to establish a connection to the station at a later time.

Bad sound quality at certain internet radio stations

Cause:

The station transmits with a low audio bandwidth (low bitrate).

Remedy:

Use stations transmitting at least at 128 kBit/s. This is the lowest recommended bitrate for adequate sound quality. For good sound quality we recommend high bitrates like 320 kBit/s

Appendix A

Wiring diagram

PDT 3100 HV

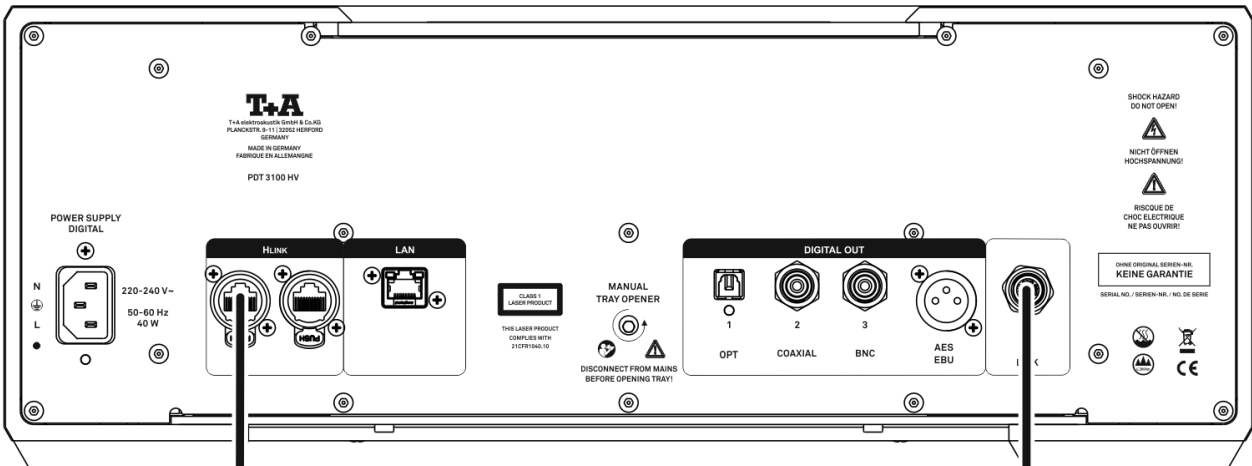

SDV 3100 HV

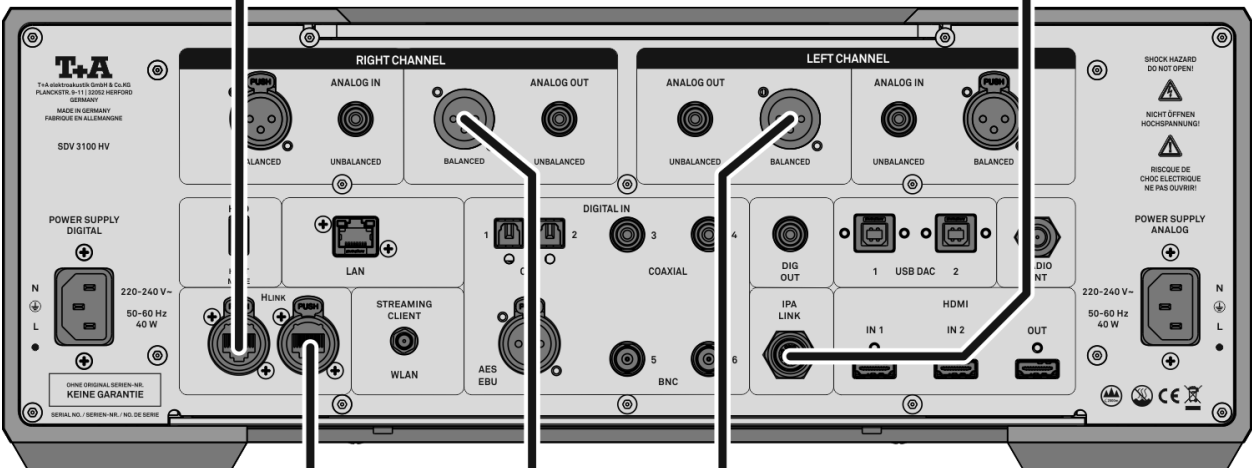

A 3000 HV

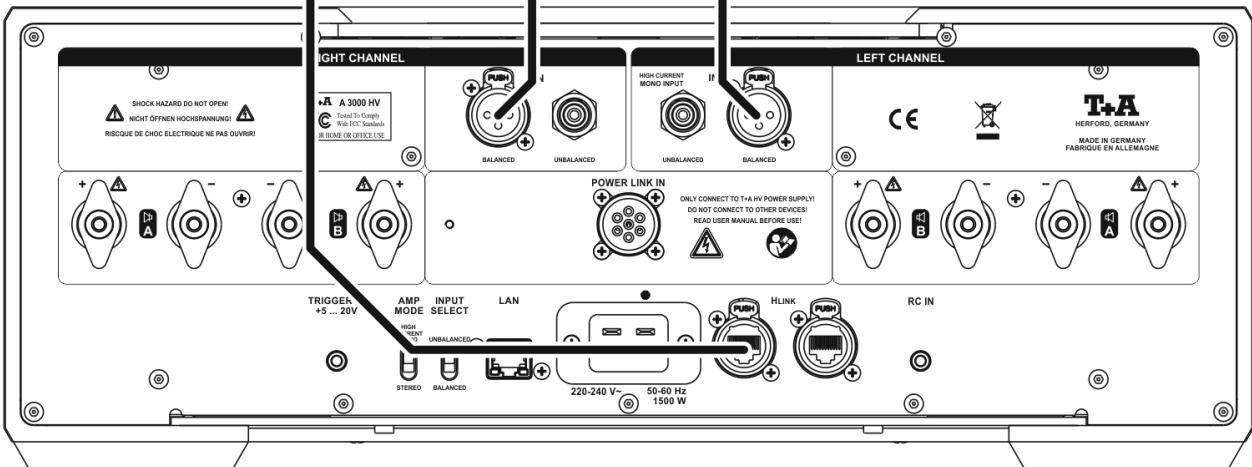

* If both types of connection are present on the amplifier, we recommend the symmetrical option

Wiring diagram

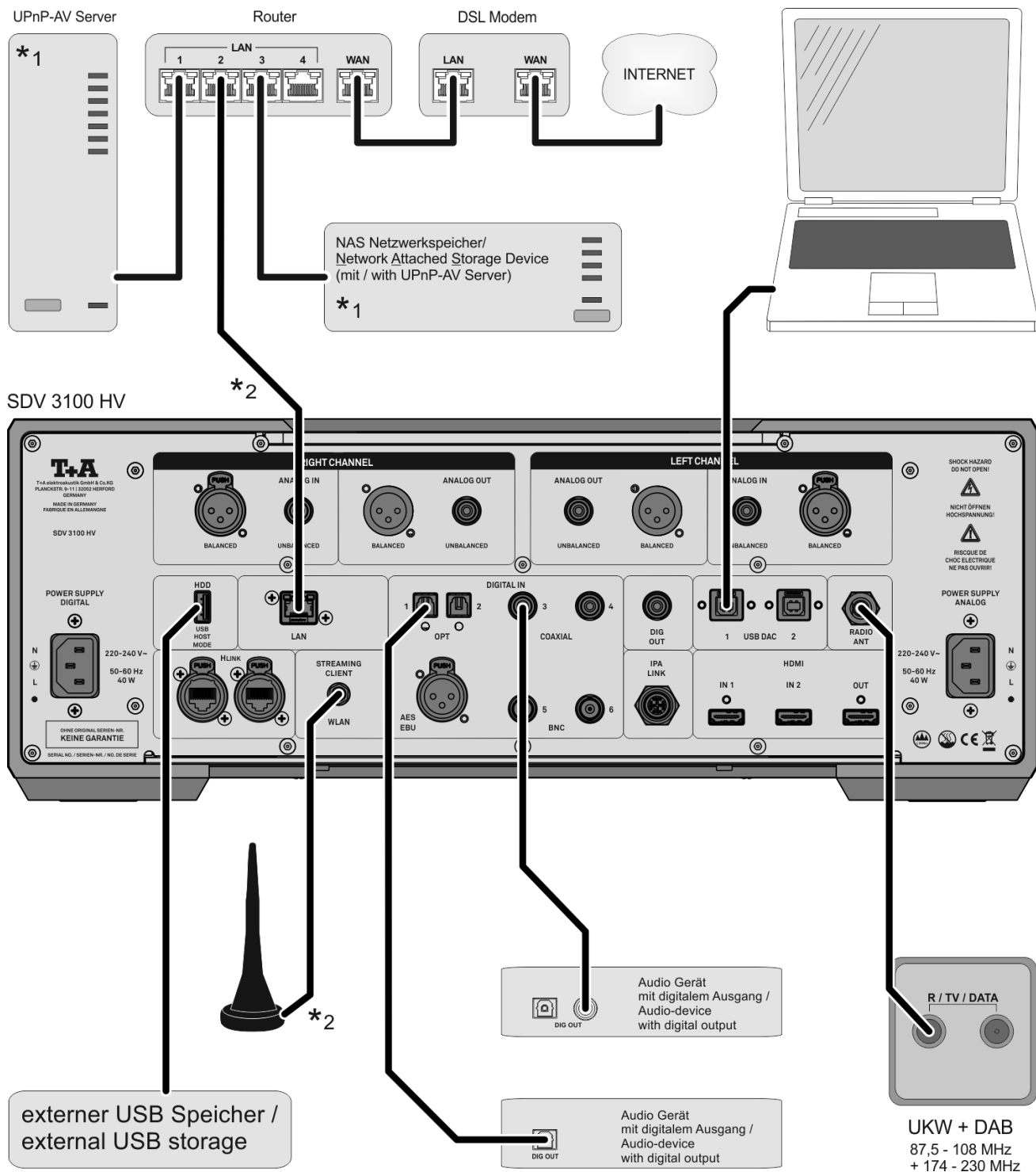

Attention!

A properly set up home network with router must be installed and in operation to use the **SDV 3100 HV**.
 For the use of internet radio a DSL access to the internet is needed.
For questions regarding setting up your network and internet connection please ask your system administrator or any network specialist.

*1 Music Server with UPnP-AV server software installed

*2 Connection either via Cable-LAN or Wireless-LAN

Wiring diagram

Network Audio (NAA source)

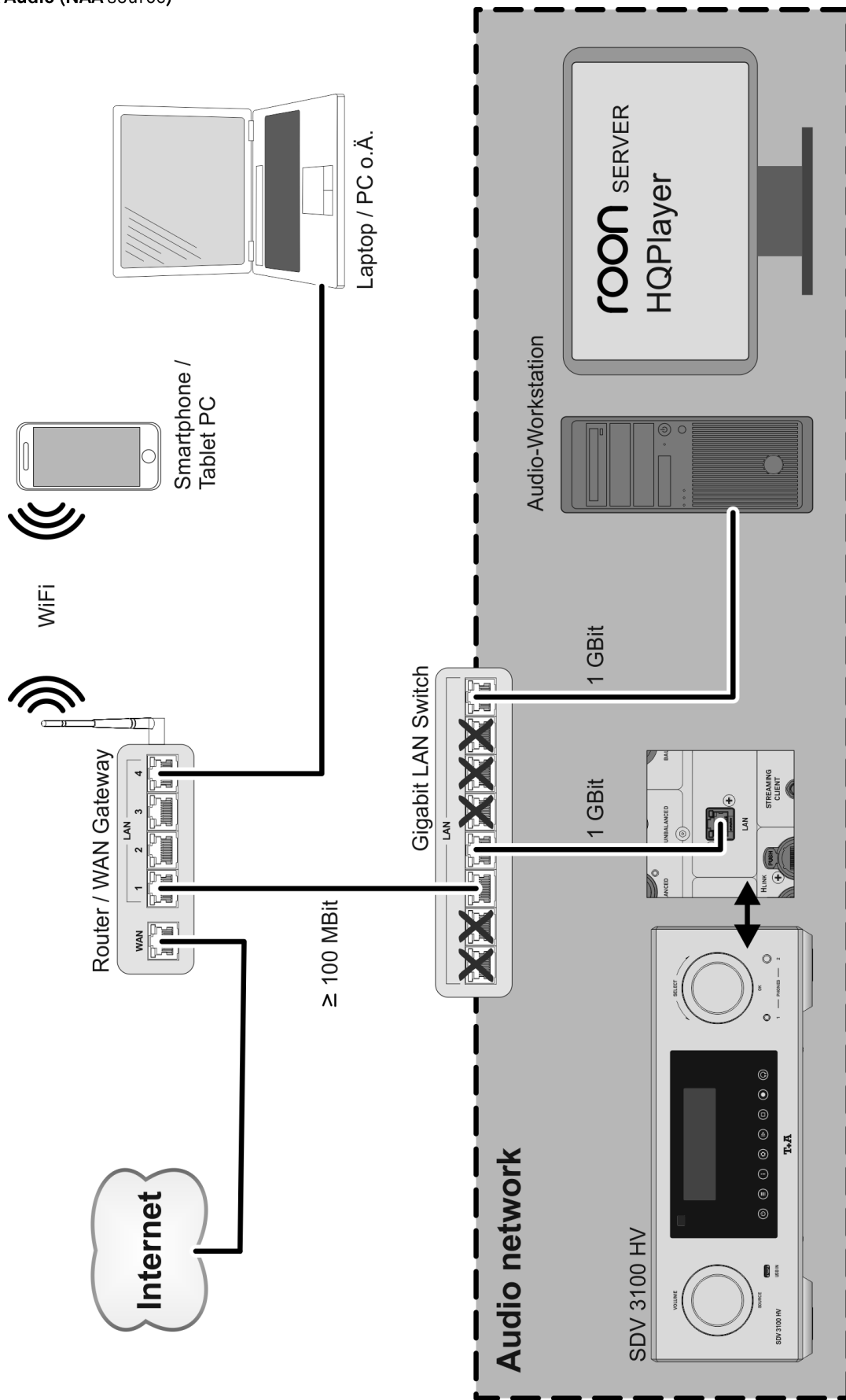

Wiring diagram

Note!

Please note that the digital radio DAB+ and the analogue FM radio transmitting in different frequency ranges. Depending on the existing antenna configuration, it may therefore be necessary to combine the two ranges with a DAB+/UKW feed-in crossover. When using an indoor antenna, do not place it in close proximity to sources of interference such as cordless telephones, WLAN routers or LED lights.

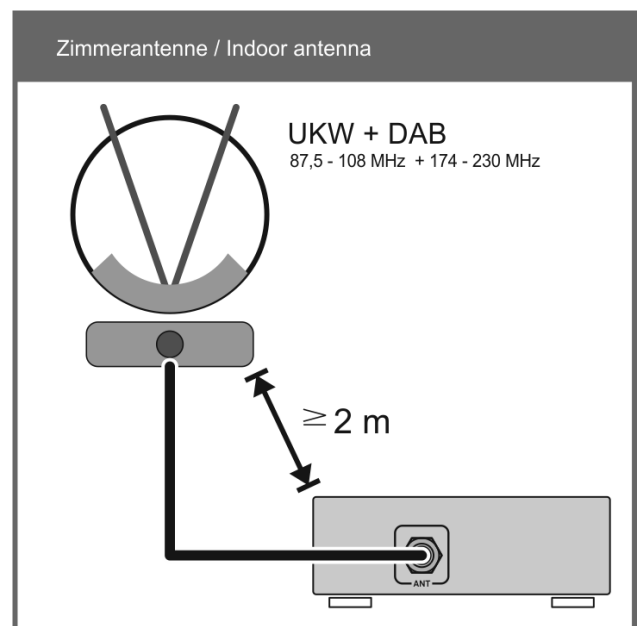
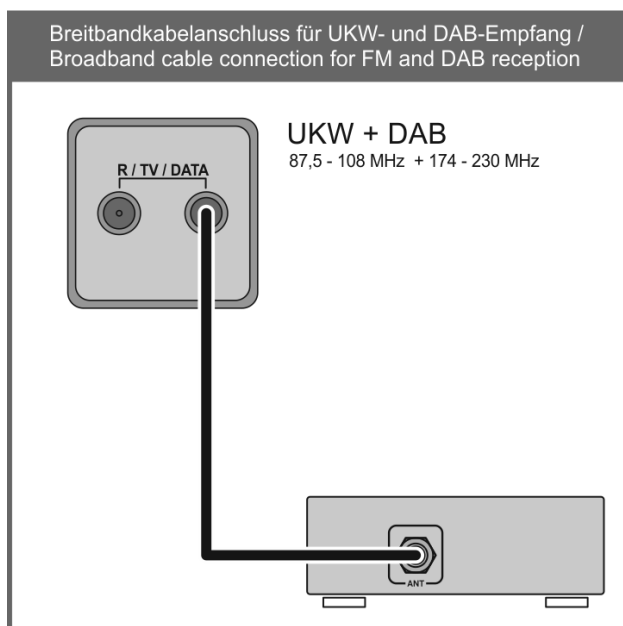
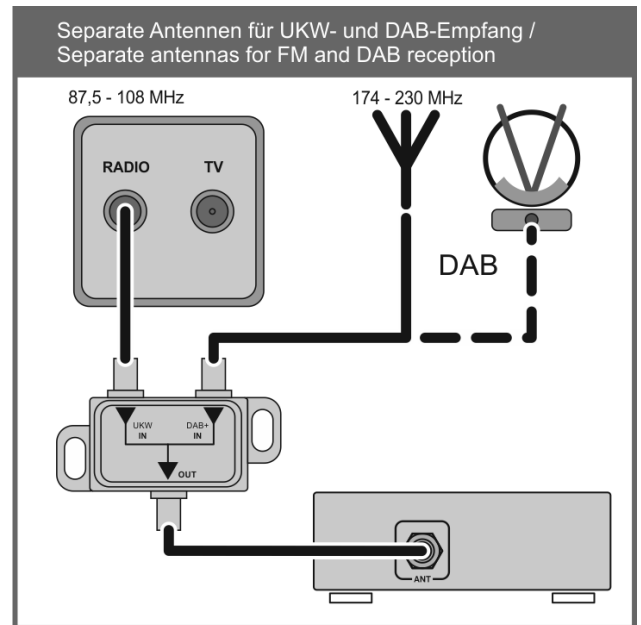
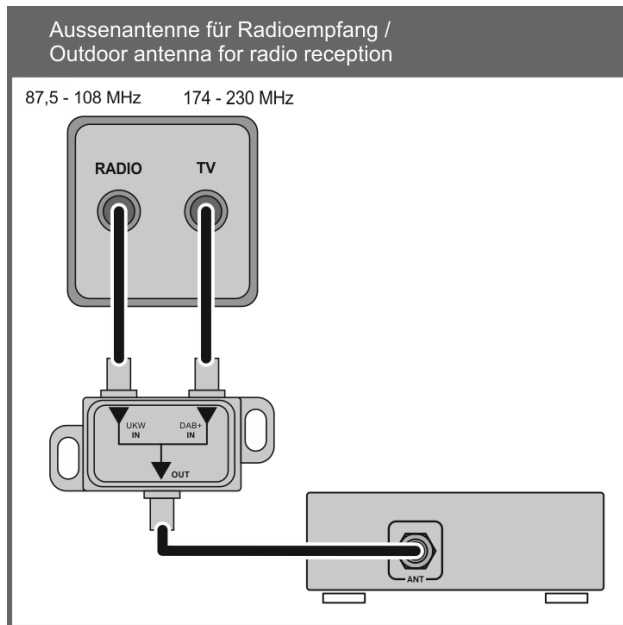

Appendix B

Specification

Streaming Client

Formats	MP3, WMA, AAC, OGG Vorbis, FLAC, WAV, AIFF, ALAC / UPnP AV, T+A Control
Data rates	PCM 32...192 kHz, 16/24 Bit; MP3 bis 320 kBit, konstante und variable Datenrate
Services	Tidal, Deezer, qobuz. (Abonnement erforderlich)
Features	Gapless Playback für MP3 (Lame), WAV, FLAC. T+A Control App für iOS und Android)

Tuner

Internet Radio	
FM, FM-HD	87,5 - 108 MHz; sensitivity 1 μ V; S/N > 65 dBA
DAB, DAB+	168 -240 MHz (Band III); Sensitivity 2,0 μ V, S/N > 96 dBA
Features	RDS/RDBS, Stationname (PS), Programm type (PTY), Radiotext (Rt)

Bluetooth

Bluetooth standards	Bluetooth standard BT 4.2
Profiles	A2DP 1.2 (Advanced Audio Distribution Profile), AVRCP 1.5 (Audio Video Remote Control Profile) / aptX [®] , MP3, SBC, AAC.
Frequency band	2,4 GHz
Max. transmit power	+4dBm (2,5 mW)

Connections

Analogue inputs	
asymmetric co-axial (RCA)	250 mVeff ... 9 Veff / 10 kOhm
symmetric (XLR)	500 mVeff ... 18 Veff / 20 kOhm
Analogue outputs	
asymmetric co-axial (RCA)	nom 1 Veff, max 9,5 Veff / 50 Ohm
symmetric (XLR)	nom 1,45 Veff, max 19,6 Veff / 50 Ohm
Output digital	1x co-ax, IEC 60958 (LPCM)
Digital inputs	1x AES-EBU 192 kSps /24 bit 6x S/P-DIF: 2x standard coax, 2 high quality BNC and 2 optical TOS-Link (32...192kSps / 16-24 bit). 2x USB: Device-Mode up to. 768 kSps (PCM) and DSD1024*, supports asynchronous data transfer, * DSD512 and DSD1024 only with a Windows PC with appropriate driver installed or with a Linux PC with Kernel 4.4 or higher.
Network connection	LAN: Fast Ethernet 10/100/1000 Base-T, WLAN: 2,4 GHz, +20 dBm (100 mW), IEEE 802.11 b/g/n

D/A-Converter

PCM	Double-Differential-Quadruple-Converter with 4 D/A converters per channel, 32-Bit Sigma Delta, 705,6 / 768 kSps.	
DSD	T+A True-1Bit DSD D/A-Converter native bitstream, up to DSD 1024	
Upsampling (PCM)	Programmable Digital Signal Processor with 4 selectable oversampling algorithms: FIR short, FIR long, Bezier/IIR, Bezier	
Analogue filter	Phase-linear Bessel filter 3 rd order, switchable 60 kHz or 120 kHz	
Frequency response	PCM 44.1 kSps: 2 Hz - 20 kHz PCM 48 kSps: 2 Hz - 22 kHz PCM 96 kSps: 2 Hz - 40 kHz PCM 192 kSps: 2 Hz - 80 kHz PCM 384 kSps: 2 Hz - 100 kHz PCM 768 kSps: 2 Hz - 120 kHz	
	DSD 64: 2 Hz - 44 kHz	DSD 128: 2 Hz - 60 kHz
	DSD 256: 2 Hz - 80 kHz	DSD 512: 2 Hz - 100 kHz
	DSD 1024: 2 Hz - 120 kHz	
Total harm. distortion	< 0.001 %	
Signal : noise ratio, A-weighted:	117 dB	
Channel separation	110 dB	

Power requirement

230 V version	2x 220 - 240 V~, 50-60 Hz	
115 V version	2x 110 - 120 V~, 50-60 Hz	
Power consumption	max. 2x 40 W Standby < 0,5 W	

Dimensions and weight

H x W x D [cm]	17 x 46 x 46	
	26 kg	

Accessories

	Remote control F3100, W-LAN aerial, BNC to RCA adaptor, 2x power cord, XLR cord, RCA cord, USB cable, FM aerial, HLink cable, user manual	
--	---	--

We reserve the right to alter specifications.



T+A elektroakustik GmbH & Co. KG
Planckstraße 9 – 11
D - 32052 Herford

T +49 (0) 5221 / 7676-0
F +49 (0) 5221 / 7676-76

info@ta-hifi.com
www.ta-hifi.com